

BeoVision 9

Guide

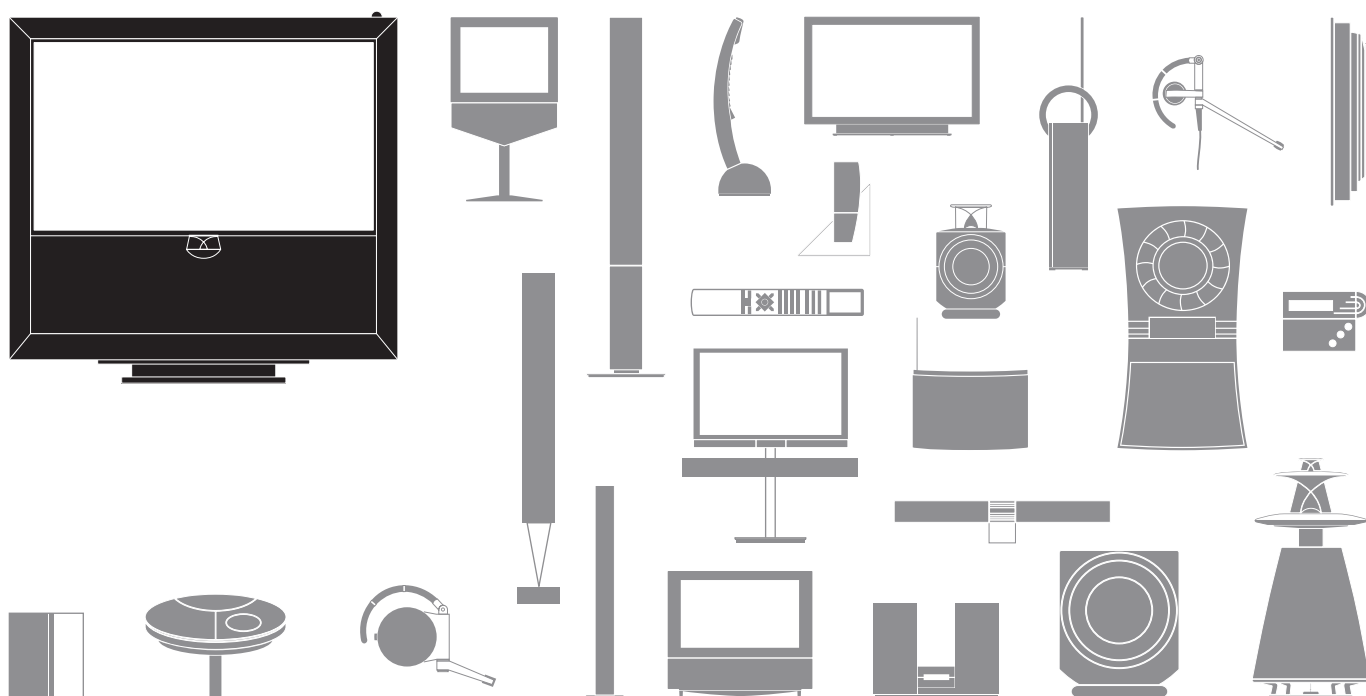

Cautions

- Make sure that the product is set up, placed and connected in accordance with the instructions in this Guide.
- Place your product on a firm and stable surface. To prevent injury, use Bang & Olufsen approved stands and wall brackets only!
- Do not place any items on top of your product.
- Do not subject the product to high humidity, rain or sources of heat.
- The product is developed for indoor use in dry, domestic environments only. Use within a temperature range of 10–35°C (50–95°F), and at an altitude of no more than 1500 m (5000 ft).
- Do not place the TV in direct sunlight, as this may reduce the sensitivity of the remote control receiver.
- Leave enough space around the product for adequate ventilation.
- Do not connect any of the products in your system to the mains, until you have connected all the cables.
- Do not attempt to open the product. Leave such operations to qualified service personnel.
- The product can only be switched off completely by disconnecting it from the wall socket.



Dear Customer

This Guide contains information about the daily use of your Bang & Olufsen product and about connecting and operating external equipment. We expect your retailer to deliver, install and set up your product.

On the Bang & Olufsen website, www.bang-olufsen.com, you can find further information and relevant FAQs about your product.

The needs of the user are considered carefully when designing and developing Bang & Olufsen products. Therefore, please take the time to tell us about your experience with your product.

To contact us, visit our website on ...
www.bang-olufsen.com

or write to: Bang & Olufsen a/s
BeoCare
Peter Bangs Vej 15
DK-7600 Struer

or fax: Bang & Olufsen
BeoCare
+45 9785 3911 (fax)

Contents













4	Watch television
6	Teletext
8	HDR – Pause and replay
10	HDR – Recordings
12	Access to BeoMaster 5
15	BeoLink
25	Advanced use
43	Installation – setup

How to use your remote control

You can operate your television with Beo5 or Beo4. The instructions in this Guide are mainly based on Beo5.



















Beo5 operation

-  **TV** Soft button, touch screen to select*¹
Switch on a source or select a function
-  **Back up through Beo5 displays**
-  **Bring up SCENE buttons, such as Zones or Speaker**
Press again to return
-  **Bring up digits to select channel or recording**
Press again to return
-  **STOP** Back up through menus or press once to pause playback and twice to stop
-  **PLAY** Start playback
-  **BACK** Exit menus completely
-  **Select colour specific functions*²**
Press volume wheel next to the colour
-  **Turn to adjust volume**
To mute, turn quickly counter-clockwise
-  **GO** Press centre button to accept and store settings
-  **Step through screen menus**
-  **Search backwards or forwards**
Recordings
-  **Step through channels or recordings**
Hold for continuous step
-  **Standby**

Beo4 operation



-  **TV** The Beo4 display shows you the activated source or function
-  **TV** Switch on the TV*³
-  **V.MEM** Switch on the hard disc recorder
-  **RECORD** Press twice to start a recording
-  **0-9** Select channels and enter information in on-screen menus
-  **MENU** Bring up the main menu of the active source
-  **TEXT** Switch on teletext
-  **Search backwards or forwards or move in menus**
-  **GO** Accept and store settings and start playback
-  **Step through channels or move in menus**
Hold for continuous step
-  **Select colour specific functions**
-  **Adjust volume**
To mute, press the middle of the button
-  **LIST** Display extra 'buttons' on the Beo4
Press repeatedly to change 'buttons'
-  **STOP** Back up through menus or press once to pause playback and twice to stop
-  **EXIT** Exit menus
-  **Standby**

Useful hints

- ¹About buttons** Light grey buttons indicate that you have to press a text in the display. Dark grey buttons indicate that you have to press a hard button.
- ²Coloured buttons** Press the wheel next to the colour to activate a coloured button.
- Actual zone** Indicates the actual zone as it was named during the setup process.
- Soft buttons** Depending on the activated source, different soft buttons appear on the screen. Touch the screen to activate the function.

³Marked buttons can be reconfigured during the setup process. See p. 47.

My reconfiguration:

 _____

 _____

NOTE! For general information about remote control operation, see the Guide enclosed with your remote control.

Watch, record or store movies and listen to different sources, such as the optional hard disc recorder, a connected set-top box or a music centre.

Display and menus

Information about the selected source is shown at the top of the screen. On-screen menus allow you to adjust settings.

...	TV	or	V.MEM	Menu
Select TV's zone	Switch on TV		Switch on hard disc recorder	Show menu

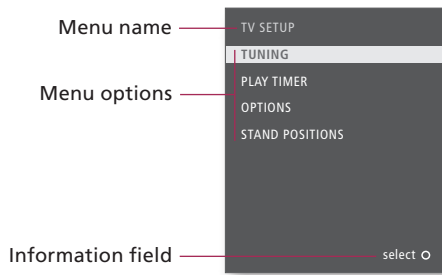

Navigate in menus

When a menu is on the screen, you can move between menu options, reveal settings or enter data.

< ◊ >	+	0-9	GO	[Colorful arrows]	BACK
Select option/ setting	Enter data		Bring up sub-menu/store setting	Select option	Exit menus ⁴

Important – for more information: www.bang-olufsen.com

Remote control The instructions in this Guide are mainly based on the Beo5 remote control, but you can also operate the TV with Beo4. On the fold-out page in this Guide, you will find an overview of the buttons on Beo5 and Beo4. For general information about remote control operation, see the Guide enclosed with your remote control.

⁴*NOTE! Press STOP to back up through menus.

Watch television

Choose a TV channel by its number or switch to another channel or source. Adjust the sound volume, change the sound type or language and turn the TV.

Activate the TV source to use these functions



Beo5 operation

Switch on the TV

Select a TV channel

Bring up a channel list

Adjust the volume

Record here and now

While recording you can also watch another recording, source, or TV channel.*¹

Turn the TV

See second source

Divide the screen to watch two sources at the same time.

Switch off the TV

Automatic colour calibration may start automatically.

Useful hints

¹***Record here and now** You cannot start a new recording if a recording is already in progress, or if the optional hard disc recorder is full of protected recordings. Also, you cannot watch one set-top box programme while recording another.

Automatic Colour Management Automatic Colour Management automatically compensates for colour changes on the screen for every 100 hours of use approximately. Do not switch off the system or disconnect it from the mains during the calibration.



Beo4 operation

TV	Press
or 0-9 Previous	Select Activate numbers Select channel Select previous channel
or 0-9	Hold for channel list Select page Select channel Accept
	Adjust volume. To mute, turn quickly counter-clockwise
	Bring back the sound by turning the wheel either way.
Record Record STOP STOP	Start recording Stop recording
Stand or or Position 1...9	Press Press Turn TV Select position* ²
P-and-P DVD Swap	Press Select source Swap pictures
	Press

TV	Press
or 0-9 0	Select Select channel Previous channel
or	Hold to activate Select page or channel and accept
	Adjust volume To mute, press in the middle of the button
RECORD STOP	Press twice to start Press twice to stop
LIST or 1-9	Select STAND Turn TV Select position* ²
LIST DVD 0	Select P-AND-P Select source Swap pictures
	Press

Second source You can bring up two video sources. With **Swap** you can make the left and right pictures switch places. With **BACK** you leave the function and go to the source on the left. You can also just select the source you wish to go to. See also p. 50 for information about HDMI sources.

²***TV positions** **Position 1** is the far left position and **Position 9** is the far right.

NOTE! To use the stand function, you have to calibrate the stand first, see p. 53. To preset positions for the TV to turn to, see p. 56.

Teletext

Operate teletext through the menu bar at the top of the teletext page or the arrow buttons on your Beo5.

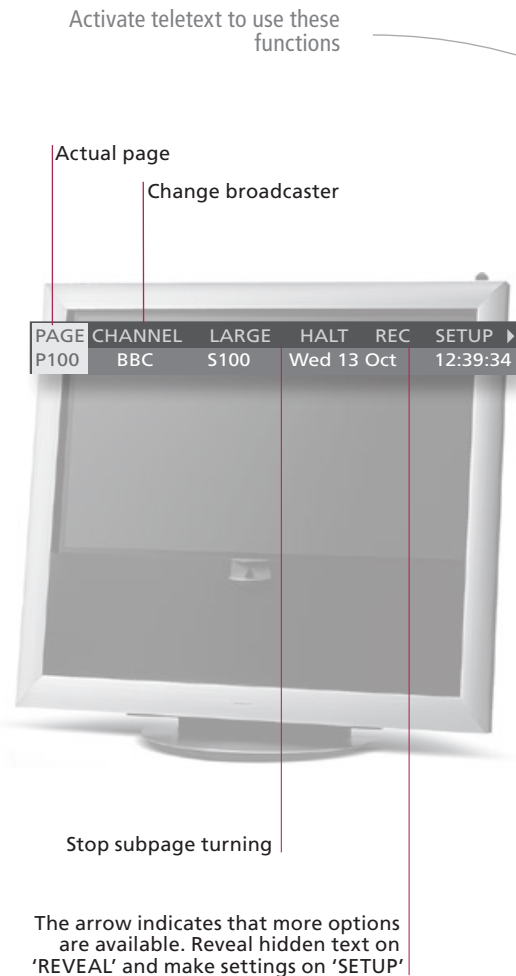

Beo5 operation



Start teletext

Access the start page of teletext.

Move to pages

Access teletext pages you wish to see.

Change teletext service*¹

Access teletext pages of other broadcasters.

Stop subpages from turning

Reveal hidden messages

... and the like.

Create MEMO pages

Nine MEMO pages are available for each channel's teletext service.*²

View a MEMO page

'MEMO' is only available if you have stored MEMO pages.

Delete a MEMO page

Exit teletext

Leave the teletext function.

Glossary

- Beo5 teletext point** With the inner arrow buttons on Beo5 you can navigate in page references in a teletext page. Go to a page referred to by pressing the **centre** button and back again by pressing **BACK**.
- ¹*Teletext service MEMO pages** Each channel provides its own teletext service. Change easily between teletext pages of different channels. Store a teletext page as a MEMO page to be able to access it quickly.
- Large teletext** To enlarge the size of the teletext page, bring up teletext, move to 'LARGE' in the menu bar and press the **centre** button repeatedly to switch between the upper and lower half of the page and normal page size.



Beo4 operation

Text	Press repeatedly to change screen mode				
0-9	or	<	◊	GO	
Select page		Move to 'PAGE'	Select page	Go to index pages (100, 200, 300 ...)	
>	◊	GO	◊	GO	
Move to 'CHANNEL' or 'MEMO' then 'CHANNEL'		Bring up channel list	Select channel	Accept	
STOP	or	<>	GO	◊	or 0-9 GO
Stop turning	Move to 'HALT'	Press	Select subpage	Restart turning	
<>	GO				
Move to 'REVEAL'	Accept				
0-9	<>	GO	GO	<>	GO
Select page	Move to 'SETUP'	Accept	Store current page	Move to 'BACK'	Accept
<>	◊				
Move to 'CHANNEL' or 'MEMO'	Select MEMO page				
<>	GO	<>			
Move to 'SETUP'	Accept	Select MEMO page	Press	Delete	
BACK					
Press					

TEXT	Press		
0-9	or	◄	◊ GO
Select page	Move to 'PAGE' and select	Index pages	
►►	◊ GO	◊ GO	
Move to 'CHANNEL' or 'MEMO' then 'CHANNEL'		Press, select channel and accept	
STOP	◊	or	0-9 GO
Stop turning	Select subpage and restart turning		
◄►	GO		
Move to 'REVEAL'	Accept		
0-9	◄►	GO	GO
Select page	Move to 'SETUP'	Accept then store	
◄►	◊		
Move to 'CHANNEL' or 'MEMO'	Select MEMO page		
◄►	GO	◄►	
Move to 'SETUP'	Press	Select page	Press twice
EXIT			
Press			

²***Teletext subtitles** If you would like available teletext subtitles to appear automatically for a particular channel, store the teletext subtitles page as MEMO page 9.

Dual screen When teletext is activated, pressing **Text** swaps between dual screen and full screen mode.

NOTE! If your TV is linked via a Master Link cable to another TV, stored MEMO pages are not shared among these TVs. MEMO pages must be stored manually on each linked TV.

HDR – Pause and replay

With the optional hard disc recorder, pause, repeat and resume the current programme. The TV continues saving during replay, so you are sure to see the entire programme.

The current channel is saved in a three-hour replay buffer

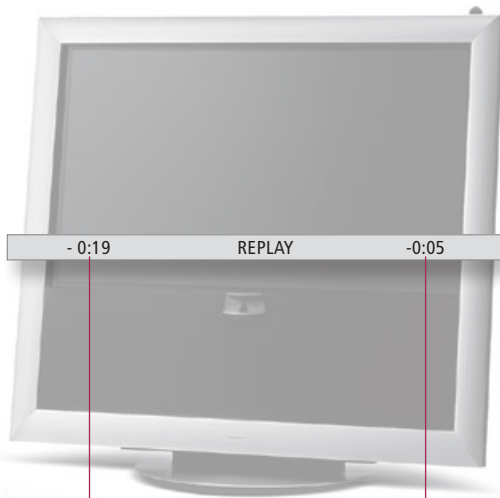

19 minutes are saved in the replay buffer

The current picture is 5 minutes behind the live signal



Beo5 operation

Pause

Pause the programme on the current channel.

Replay

Replay a programme that you have paused.

Go to a specific point

Enter a specific time to go to in the buffer content.

Step backwards or forwards

Step backwards or forwards minute by minute.

Cue backwards or forwards

Press button again to change speed.

Pause replay

Pause replay of the buffer content.

Save the replay buffer

Save the buffer contents to the hard disc recorder.

Go to live signal or replay mode

Switch between the live signal and replay mode.

Glossary

Replay You cannot pause or replay a programme while the TV is recording another programme or copying a recording, nor can you pause or replay programmes copy-protected by Macrovision. If you pause a programme for three hours, the TV automatically starts replay from the point at which you paused the programme.

Slow replay Slow replay backwards is not possible.

Save the replay buffer Copy the content of the replay buffer to the 'HARD DISC CONTENT' list. The content before the recording start time will be deleted when the TV is switched off.



Beo4 operation

	Press	To return to live signal, select source again, such as TV
or	Replay	Slow replay, press again to change speed
	Activate numbers	Select point
	Step	
or	Backwards	Forwards
	Press	You can step frame by frame
	Search for start point	Stop searching Activate saving Accept saving
	Go to live signal	Return to replay mode

	Press	To return to the live signal select the source again
or	Replay	Slow replay, press again to change speed
	Select point	
	Step	
or	Backwards	Forwards
	Press	You can step frame by frame
	Search for start point	Stop searching Press twice to accept
	Go to live signal	Return to replay mode

Switching source You can switch from one live source, such as TV.TUNER, to another, such as STB, at any time, but the source you leave is no longer saved to the buffer after the switch. Instead the new source is saved. Switching to a non-live source, such as DVD, causes the TV to stop saving to the buffer and ends replay.

NOTE! The content of the replay buffer is not protected. If the buffer is full and you continue to save programmes to it, the oldest content is deleted. If you switch off the TV, the content of the buffer is deleted after 60 sec.

HDR – Recordings

Use the optional hard disc recorder to play recordings stored on its hard disc. Playback of recordings begins automatically after a few seconds.

Activate the source of the hard disc recorder to use these functions

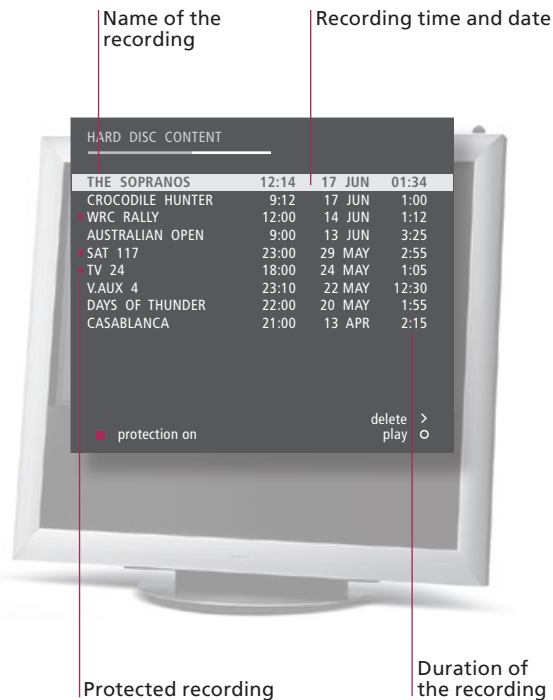

Beo5 operation



Switch on the hard disc recorder

It takes up to 40 seconds to start the recorder.

Select and play a recording

Pause or stop playback

Pause or stop playback of a recording.

Switch to previous or next

Switch to the previous or next recording within a group.

Go to a specific point

Enter a specific time to go to in a recording.

Step or cue backwards or forwards

Step backwards or forwards minute by minute. Press button again to cue faster.

Browse through recordings

During playback, you can see a short list of recordings from the chosen group.

Switch off the recorder

Glossary

Playback information

To bring up playback information during playback, press the **centre** button. To remove the information, press **BACK** or wait three seconds.

Pause and stop playback Browse through recordings

When the picture remains unchanged for eight minutes, the TV screen dims automatically. Show up to five recordings at a time during playback. You can browse through recordings in Groups if you have set 'FEATURE LEVEL' to 'ADVANCED' and placed recordings in the predefined Groups. See pp. 28 and 57 for more information.



Beo4 operation

V.MEM

Select source of recorder. Playback begins automatically of the last viewed recording, the newest recording or a recording in progress.

Menu **GO** **◀▶** **PLAY** or **[Blue Bar]**
 Open 'HARD DISC CONTENT' menu Select recording Play recording Slow replay

STOP **STOP** **◀▶**
 Pause Stop From pause mode, step frame by frame

◀▶
 Previous/next

+ **0-9**
 Activate numbers Select point

◀▶ **[Green Bar]** **[Orange Bar]**
 Step backwards/forwards Cue backwards/forwards

GO **◀▶** **PLAY**
 Press twice Select recording Play recording

TV or **[Red Dot]**
 Switch source Switch off TV

V.MEM

Select source of recorder

MENU **GO** **◀▶** **GO**
 Open 'HARD DISC CONTENT' menu Select and play

STOP **STOP**
 Pause Stop

◀▶
 Previous/next

0-9
 Select point

◀▶ **[Green Bar]** **[Orange Bar]**
 Step backwards/forwards Cue backwards/forwards

GO **◀▶** **GO**
 Press twice Select recording Play recording

TV or **[Red Dot]**
 Switch source Switch off TV

Playback When you select a recording to play, the TV resumes playback from where you left off the last time the same recording was played. If you have viewed the recording to its end, playback starts from the beginning. Unless otherwise instructed, the TV plays the selected recording through to the end. The recording is then paused.

Slow playback Slow playback backwards is not possible.

NOTE! You can bring up the 'HARD DISC CONTENT' menu if you press and hold the **centre** button. The bar at the top indicates how full the hard disc is. A red dot indicates if a recording is protected. For information about protection, see p. 27.

Access to BeoMaster 5

If your TV is equipped with the optional BeoMaster, you can bring up BeoMaster sources on the TV screen to get access to N.Music, N.Radio, photos, and web.

Activate the BeoMaster in order to use these functions



Beo5 operation

Select a BeoMaster source

When you have brought up the source selection menu, choose from different media sources.

Select function*¹

The menu overlay gives you quick access to selected functions.

Switch off the BeoMaster

Useful hints

¹***Menu overlay** The menu overlay shows the options you have with a selected source.



Beo4 operation

PC
Press

◊ **GO**
Select source

LIST **GO**
Select PC

◊ **GO**
Select source

Menu
Show menu overlay

+ **0-9** or **GO** or **BACK**
Select function

MENU **0-9** or **GO** or **EXIT**
Show menu overlay and select function

TV or **●**
Switch source Switch off TV

TV or **●**
Switch source Switch off TV

Remote control Use your remote control to switch sources on and off, search for specific stations or tracks, access additional functions, and adjust volume.

NOTE! For further information about the BeoMaster, refer to the Guide enclosed with your BeoMaster.



- 16 BeoLink system
- 18 Connect and set up an audio system
- 20 Connect and set up a BeoLink system
- 21 Your television in a link room
- 22 Two televisions in the same room



BeoLink system

If you have a BeoLink system, you can operate all connected sources from both the main room and link rooms.

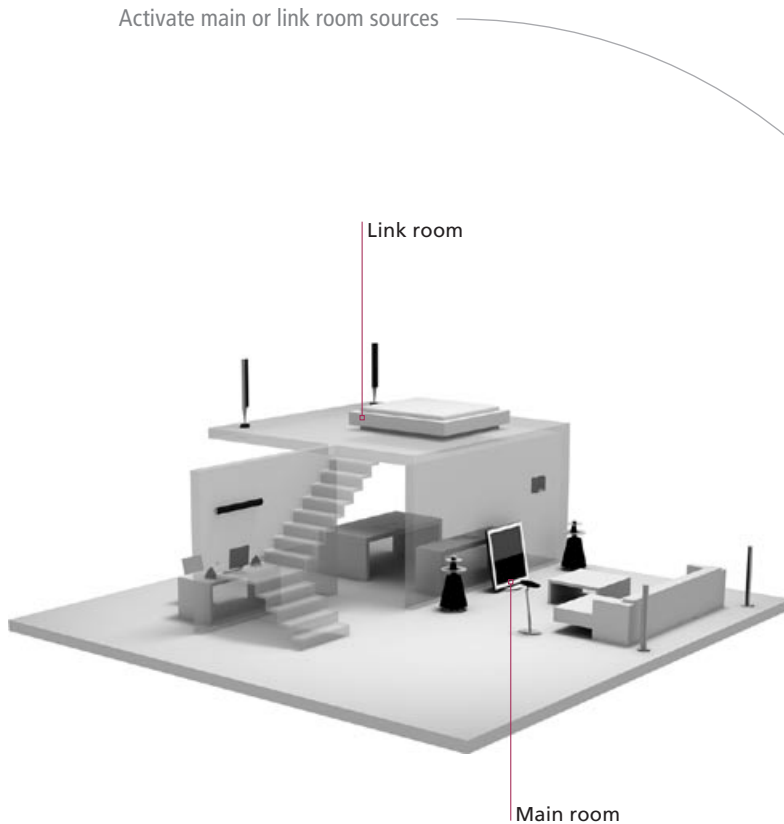

Beo5 operation



TV sound on the audio speakers

Listen to sound from a TV source on your audio system speakers.

Audio sound on the TV speakers

Listen to audio sound on the speakers connected to the TV.

Use a source present in one room

Activate a main or link room source from a link room. The source type is only present in one room.

Use a link room source

Activate a link room source in a link room. The source type is present in both rooms.

Use a main room source

Activate a main room source from a link room. The source type is present in both rooms.

Stereo sound in a link room

If stereo sound is selected in the link room, you cannot distribute other main room sources to the link room system.*¹

Useful hints

Options	To use all functions properly, the products must be set to the correct options. See p. 18.
Main room source	This is the central source from which you can distribute sound and pictures to link room sources.
Link room source	This source is placed in the link room and through the source you can receive sound and pictures from connected main room sources.
Audio system	Only Bang & Olufsen audio systems with Master Link support integration with the TV.

...	TV	Select audio speaker zone	Select video source
...	CD	Select TV speaker zone	Select audio source
RADIO		Select source	Operate source as usual
TV		Select source	Operate source as usual
Link	TV	Press	Select source Operate source as usual
TV	AV	Switch on TV	Press Select main room source



Beo4 operation

LIST	TV	Select AV* ²	Select video source
LIST	CD	Select AV* ²	Select audio source
RADIO		Select source	Operate source as usual
TV		Select source	Operate source as usual
LIST	TV	Select LINK* ²	Select source Operate source as usual
TV	LIST	Switch on TV	Select AV* ² Select main room source

¹*Sound Usually sound distributed from a main room video source, such as a set-top box, to the link room is transmitted in mono. However, you can select stereo sound.

Changes in link room setup If you move your link room products to other rooms, remember to get your Beo5 remote control reconfigured by your Bang & Olufsen retailer.

²*NOTE! In order to display AV and LINK on Beo4, you must first add it to the Beo4 list of functions. See the Guide enclosed with your Beo4.

Connect and set up an audio system

To obtain the benefits of an integrated audio/video system, connect a compatible Bang & Olufsen audio system to the TV using a Master Link cable.

1. Connect the audio system

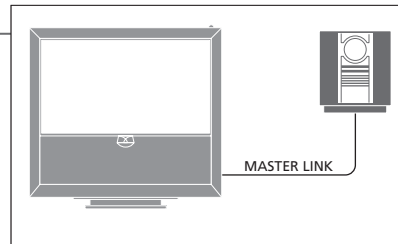

Connect the available sockets marked MASTER LINK on the TV and the audio system using a Master Link cable.

2. Set option for TV

If your TV has been set up in an audio/video system, set it to the correct option. Switch the entire system to standby first and place yourself in front of the TV.

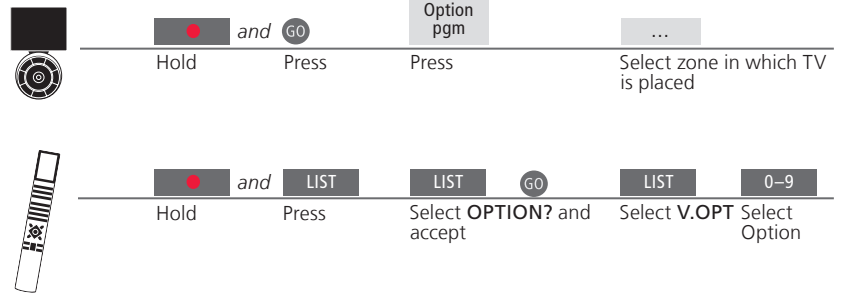

3. Set option for audio system

Set the audio system to the correct option. Switch the entire system to standby first and place yourself in front of the audio system.

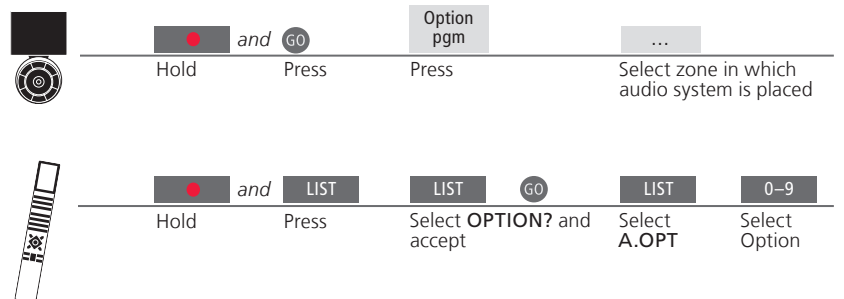

Useful hints

TV and audio speakers

Play a CD on your audio system using speakers connected to the TV, or switch on a TV programme and send the sound to your audio system speakers.

Choice of options

If you have a Beo4 remote control, options for the TV can be 1, 2, or 4 in a main room and 5 or 6 in a link room. Options for the audio system can be 0, 1, 2, 5, 6. See also p. 21.

Your audio/video system can be placed together in one room, or in two rooms with the TV in one and the audio system with a set of speakers in another.

Select options

To set the correct options with the Beo5 remote control, you must select the zone in which your product is placed, see p. 18. To set the correct options with the Beo4 remote control, you can get an overview of options on this page.

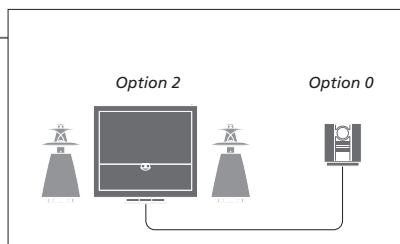

The TV and audio system are set up in one room with all speakers connected to the TV. Set the TV to Option 2 and the audio system to Option 0.

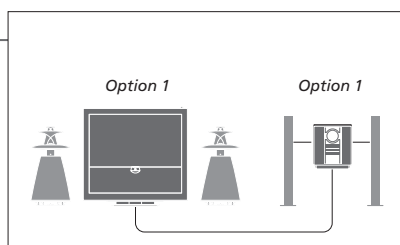

The TV with or without additional speakers and an audio system with a connected set of speakers are set up in one room. Set the TV to Option 1 and the audio system to Option 1.

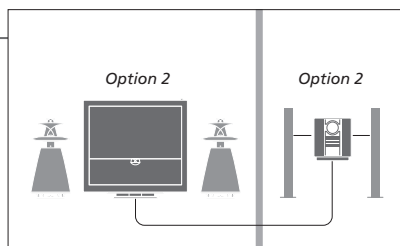

The audio system is set up in one room and the TV with or without additional speakers in another. Set the TV to Option 2 and the audio system to Option 2.

Options For information about Option 4, 5 and 6, see pp. 21–22.

NOTE! Not all Bang & Olufsen audio systems support integration with the TV.

Connect and set up a BeoLink system

Connect and set up a BeoLink system to see pictures and hear sound in link rooms. You can, for example, connect the living room TV to another video system or to a set of speakers in another room.

Make link connections

To distribute video signals to link rooms, it is necessary to connect an RF Link Amplifier to the main room TV and a link room TV.*¹

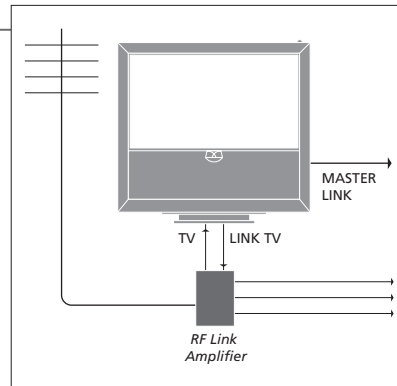

Connect the Master Link cable to the available socket marked MASTER LINK on the TV.

To distribute video signals to link rooms, connect an ordinary aerial cable to the socket marked LINK TV on the main connection panel. Then run the aerial cable to the RF Link Amplifier and the Master Link cable to the link room. Follow the instructions enclosed with the link room equipment.

Switch on the system modulator

If you have an audio setup, such as a BeoLink Active/Passive, and you set up a non-linkable TV in the same room, you must set the system modulator to 'ON'. The factory setting is 'AUTO', which must be used if you are using a linkable Bang & Olufsen TV.



Change the link frequency

If, e.g., a TV channel in your area is broadcasted on the same frequency as the factory setting for the BeoLink system; 599 MHz, you must tune the system modulator to an unoccupied frequency.*²



Useful hints

¹*Connected equipment

If an audio system is already connected to the MASTER LINK socket and you wish to connect more equipment, the Master Link cable must be split in two and joined with the cable from the link room using a special junction box. Contact your Bang & Olufsen retailer for assistance.

NOTE! Only sources with an analogue signal can be distributed from a main room TV to the link room system.

²*Link frequency

When you change the link frequency in the main room TV, make sure that the link frequency in the link room corresponds to it.

If you have a BeoLink system, operate all connected systems through the TV in a link room.

Connect link room TV

Follow the procedure described here when you connect your TV for use in a link room.

- 1 Connect the link room TV to the mains supply.
- 2 Using your remote control, programme the link room TV to the correct option.
- 3 Disconnect the link room TV from the mains.
- 4 Make the necessary connections.
- 5 Reconnect the link room TV to the mains supply.

Set option for a link room TV

For your entire system to function properly, it is essential that the TV in the link room is set to the correct option before you connect it to the system in the main room. Place yourself in front of the link room TV.

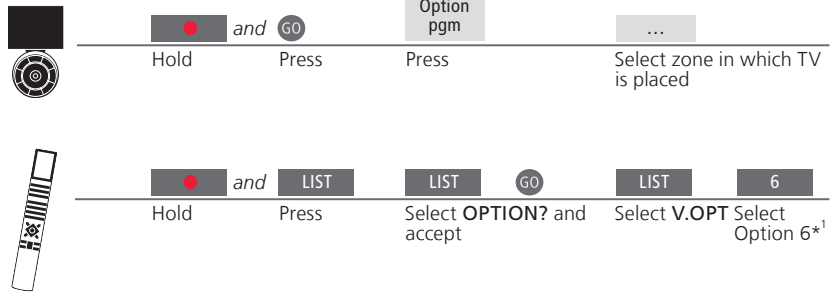

BeoMaster If your TV is equipped with a BeoMaster, it cannot be set up and used in a link room.

Timer programming Programme a Play Timer on the TV in the main room.

¹*NOTE! If you have a Beo4 and you connect the TV for use in a link room where other link systems are already connected, such as speakers, you must set the TV to Option 5 instead.

Two televisions in the same room

If you have two TVs in the same room and one remote control for both TVs, it is essential that the TVs are set to the correct options, for them to function properly.

Set the correct option

If you place your TV in a room where you already have a Bang & Olufsen TV and commands from your remote control can be received by both TVs, you must change the option of the secondary TV to prevent simultaneous activation of both TVs. Place yourself in front of the secondary TV.

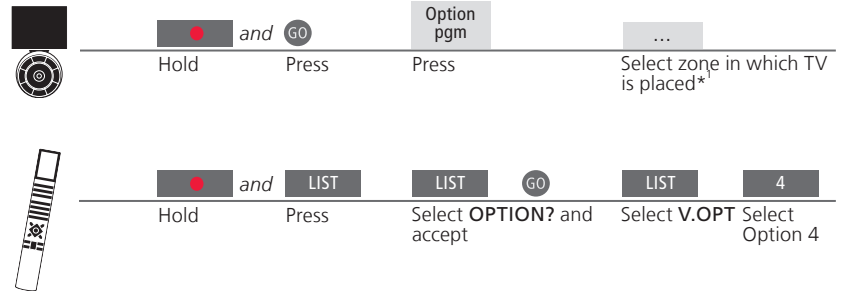

Beo5 – operate the TVs

Normally you can activate a source simply by pressing the relevant source button, but if you have two TVs in the same room, you must remember first to select the zone of the TV you wish to use, if you have a Beo5.

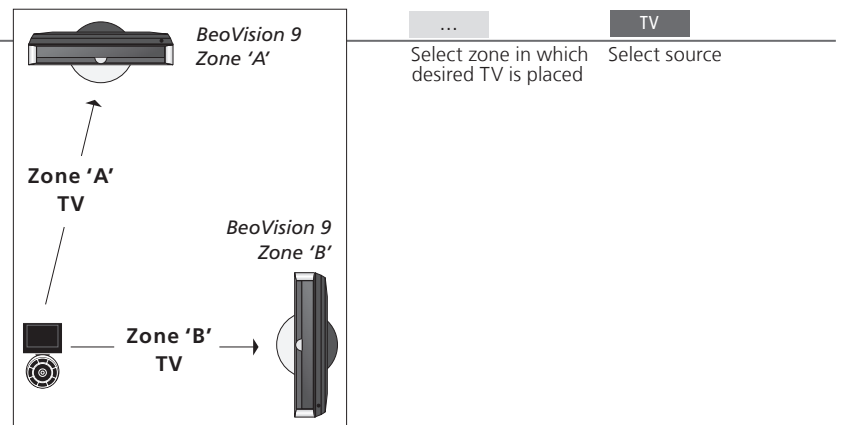

Useful hints

Teletext with Option 4 In order to use teletext on a TV set to Option 4, you must set up Beo4 to VIDEO 3. This limits the Beo4 functions that can be used with TVs set to other options. For more information, see the Guide enclosed with your Beo4.

Beo4 – operate TV in option 4

Normally you can activate a source simply by pressing the relevant source button, but if your TV is set to Option 4, you must do the following to activate a source, if you have a Beo4.

However, if you wish to dedicate a remote control to your secondary TV, contact your Bang & Olufsen retailer.

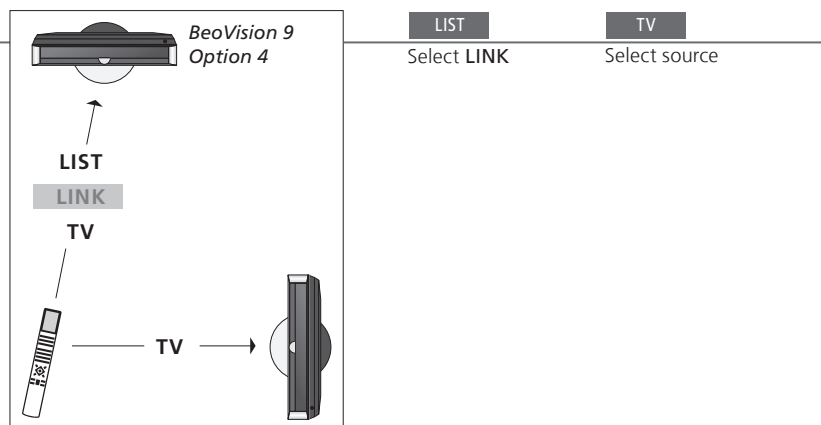

LINK on Beo4 In order to display LINK on Beo4, you must first add it to the Beo4 list of functions. See the Guide enclosed with your Beo4 for more information.

¹*NOTE! For information about choice of zone, contact your Bang & Olufsen retailer.



- 26 HDR – Record a programme
- 27 HDR – Edit recordings
- 28 HDR – Copy and group recordings
- 29 HDR – The Parental Lock
- 30 Surround sound and Home cinema
- 31 Sound type
- 32 Wake-up Timer
- 33 Play Timer
- 34 Edit and add TV channels
- 35 Adjust picture and sound settings
- 36 Calibrate colour accuracy of the screen
- 37 The pincode system
- 38 Tuner setup
- 40 Operate other equipment with Beo5 or Beo4

HDR – Record a programme

If the optional hard disc is full and you set a Timer recording or start a manual recording, the TV automatically makes room for the new recording by deleting old unprotected recordings.

Set a Timer recording

Select the hard disc recorder as source first. Set up to 15 Timers. Change from 'DATE' to 'WEEKDAYS' by means of the green button.

Bring up hard disc recorder menu

→ Select 'TIMER PROGRAMMING' menu

→ Insert and accept Timer settings

Timer recording via teletext

Programme recordings via the desired teletext page.

Bring up teletext and find desired page

→ Select 'REC' in menu bar

→ Insert and accept start/stop time

Check Timers already set

Check, edit, or delete Timers that are waiting to be executed. Timers are listed chronologically.

Bring up hard disc recorder menu

→ Select 'TIMER INDEX' menu

→ Check, edit or delete Timers

TIMER INDEX			
TV	23	12:25-13:00	17 JUN
TV	TV 2 DK	14:00-14:45	17 JUN
V.AUX	THE SOPRANOS	22:00- 23:20	19 JUN
TV	MTV	12:25-12:00	21 JUN
V.AUX 2	121	22:00-23:20	25 JUN
SAT	1222	2:00- 3:20	25 AUG
V.AUX	AUSTRALIA	12:15-12:30	25 AUG
SAT	43	23:55- 2:15	M-W--S
SAT	123	14:00-15:15	M--TF--
SAT	CROCODIL	16:10-17:15	-T-TF-S
TV	MTV	18:00-18:30	-T-TF-S
SAT	WRC RALL	13:00-13:45	---TF--

Monday
Tuesday
Wednesday
Thursday
Friday
Saturday
Sunday

Useful hints

Timer Timers can be edited while in progress, but some fields will be inaccessible. Red start and stop times in the 'TIMER INDEX' menu indicate recordings which overlap.

Timer programming The 'TIMER PROGRAMMING' menu contains additional options when you set 'FEATURE LEVEL' to 'ADVANCED'. See p. 59.

NOTE! You cannot start a new recording, if a recording is already in progress, or if the hard disc is full of protected recordings. Also, you cannot record programmes copy-protected by Macrovision.

You can protect, delete or name recordings. You can also split a recording into two separate parts or trim it. If the optional hard disc is full, the TV automatically makes room for new recordings by deleting old recordings.

Protect or unprotect a recording

Protected recordings are not deleted if a new recording is started and the hard disc is full.

Bring up hard disc recorder menu and select 'HARD DISC CONTENT' menu

→ Select recording*¹



Delete a recording

Delete a recording you do not want, including protected recordings.

Bring up hard disc recorder menu and select 'HARD DISC CONTENT' menu

→ Select recording*²



Name a recording

Name or rename a recording as often as you want.

Bring up hard disc recorder menu and select 'HARD DISC CONTENT' menu

→ Select recording



Split a recording

Split a recording into two parts.

Bring up hard disc recorder menu and select 'HARD DISC CONTENT' menu

→ Select recording



Trim a recording

Trim away a section of a recording.

Bring up hard disc recorder menu and select 'HARD DISC CONTENT' menu

→ Select recording



¹*Protect a recording If 'FEATURE LEVEL' is set to 'BASIC', simply toggle the red button to protect and unprotect a selected recording.

²*Delete a recording If 'FEATURE LEVEL' is set to 'BASIC', simply press > to mark a selected recording then the yellow button to delete it.

Max. number of recordings The max. number of recordings that can be stored on the hard disc recorder is approx. 300. If the max. number of recordings is reached, it is not possible to split recordings.

NOTE! Protected recordings are never deleted. Viewed or edited recordings are deleted before recordings that have not been viewed or edited. The oldest recordings are deleted first.

HDR – Copy and group recordings

Copy your recordings to an external video recorder to back up or to save space on the optional hard disc recorder. You can also place, move, and rename recordings in a group.

Copy to an external recorder

If you wish to copy to a non-Bang & Olufsen recorder, start a manual recording.

Bring up hard disc recorder menu and select 'HARD DISC CONTENT' menu

→ Select recording



Bring up 'EDIT'

→ Select 'EXTERNAL COPY'

Stop copying

Stop copying to an external recorder.

Bring up hard disc recorder menu and select 'HARD DISC CONTENT' menu



Stop copying

Place recordings in a group

The name of the group appears in the top right corner of the 'HARD DISC CONTENT' menu.

Bring up hard disc recorder menu and select 'HARD DISC CONTENT' menu

→ Select recording



Bring up 'OPTIONS'

→ Select 'GROUP'

→ Select group

View recordings in a group

Groups that do not contain any recordings, do not appear in the menu.

Bring up hard disc recorder menu and select 'HARD DISC CONTENT' menu



Press repeatedly to step in groups

→ Select recording

Rename a group

Rename a group, e.g. after the type of recording, or after the person who made the recording.

Bring up hard disc recorder menu and select 'SETUP' menu

→ Select 'GROUPS' menu

→ Select group



Press

→ Follow on-screen instructions

Move a group

Rearrange the order in which groups appear when you browse through groups.

Bring up hard disc recorder menu and select 'SETUP' menu

→ Select 'GROUPS' menu

→ Select group



Press

→ Follow on-screen instructions

Useful hints

External recorder If the external video recorder is from Bang & Olufsen, or if you have a Bang & Olufsen DVD Controller, the TV starts the recorder and plays the selected recording from the beginning. Otherwise, you must switch the external recorder on and start the recording manually.

Groups There are eight predefined groups: 'MOVIES', 'SPORTS', 'SCIENCE', 'NEWS', 'CHILDREN', 'TV DRAMA', 'NATURE' and 'TRAVEL'.

NOTE! We recommend that you copy your most important recordings to a recorder connected to the TV. While recording, you cannot play another recording and you cannot use the replay function.

Limit access to your recordings by activating the Parental Lock function. This requires that you have entered a Parental Lock code.

Activate/deactivate Parental Lock

Select the recordings you want to limit access to, or deactivate Parental Lock for a recording.

Bring up hard disc recorder menu and select 'HARD DISC CONTENT' menu

→ Select recording



Bring up 'OPTIONS'

→ Select 'PARENTAL LOCK' menu and follow on-screen instructions

Set a Parental Lock code

Set a four digit code to limit access to your recordings.

Bring up hard disc recorder menu and select 'SETUP' menu

→ Select 'PARENTAL LOCK CODE' menu

→ Follow on-screen instructions



Parental Lock Parental Lock is only available if 'FEATURE LEVEL' is set to 'ADVANCED'. See p. 57.

Reset Parental Lock code If you have forgotten your Parental Lock code, key in **9999** three times when 'OLD CODE' is highlighted to reset the code to 0000, which is the default setting. You can now set a new Parental Lock code.

NOTE! If you enter an incorrect code three times, the main menu appears.

Surround sound and Home cinema

When you add Bang & Olufsen loudspeakers and a projector, you can turn your TV into a Home cinema system with surround sound. You can also select a picture format to customise the viewing experience.

Select speakers for movie sound

The TV automatically selects the optimal sound, when you select a source, but you can select an available speaker combination that suits the source you are using yourself.

Bring up **Scene** display on Beo5*¹ → Select **Speaker** display → Select speaker combination*²

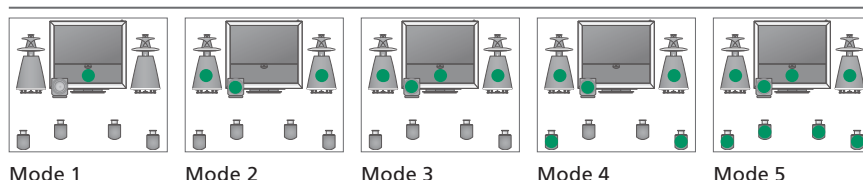

Select picture format

The TV automatically adapts the picture to fill out as much of the screen as possible, when you select a source, but you can select a format yourself.

Bring up **Scene** display on Beo5*¹ → Select **Picture** display → Select format*² → Adjust picture up or down

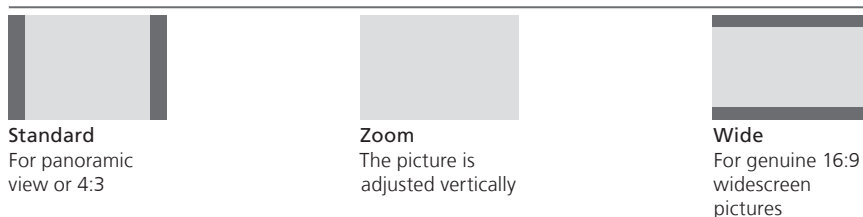

Switch to Home cinema

Move the picture from the TV screen onto a connected projector screen.

Bring up **Scene** display on Beo5*¹ → Select **Cinema** display → Select **Cinema** to switch between Home cinema and TV mode

Useful hints

¹***Scene menu** Display **FORMAT** for picture formats and Home cinema and **SPEAKER** for speaker combinations on Beo4.

²***Optimise and Variation** The speaker combination or the picture format is optimised if you press **Optimise** on Beo5. On Beo4 press **GO**. With each press on **Variation** on Beo5, you select a variation of **Standard**. On Beo4 use **◀** or **▶**.

Switch mode To switch between Home cinema and TV mode on Beo4, press **LIST** until **FORMAT** is displayed then press **0**.

NOTE! If you have added only two front speakers to the TV, you will only be able to choose **Mode 1–3**. You can add up to two BeoLab subwoofers to your TV.

While you watch TV, switch between available sound types.

Change sound type or language

Switch between available sound types and languages.

Sound

Bring up sound type

Sound

Press repeatedly to select

Sound type or language

Store your favourite sound type when tuning in TV channels. See p. 34.

Wake-up Timer

You can make the TV switch on automatically via the Wake-up Timer. A Wake-up Timer is a once only Timer which lasts for one hour and is disabled once it has been executed.

Enter a Wake-up Timer

Choose the source, channel number and start time.

Bring up 'TV SETUP' menu → Select 'PLAY TIMER' menu → Select 'WAKE-UP TIMER' menu → Enter and accept settings

Check or delete a Wake-up Timer

Check or delete the settings of a Wake-up Timer.

Bring up 'TV SETUP' menu → Select 'PLAY TIMER' menu → Select 'WAKE-UP TIMER' menu → Change and accept settings

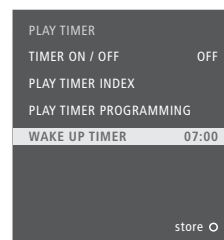

Useful hints

Wake-up Timer A Wake-up Timer applies only to the TV it has been programmed on. Make sure that the clock is set to the correct time for the Wake-up Timer to be executed correctly.

NOTE! The TV cannot be part of an ordinary Play Timer or standby Timer until the Wake-up Timer has been carried out or disabled.

You can make your TV switch on and off automatically by setting a Play Timer or a standby Timer in your main room system.

Timed play and timed standby

Preset your TV to start and stop automatically at the same time and day every week.



The source names corresponds to what the sources are registered as in the 'CONNECTIONS' menu

- TV
- DTV
- DTV2 (V.AUX)
- V.MEM
- DVD/DVD2
- V.AUX2
- CD
- N.MUSIC
- N.RADIO
- A.MEM
- RADIO
- DTV RADIO
- STANDBY

Switch on the Play Timer

To include the TV in the Play Timer, set the Timer to 'ON'.

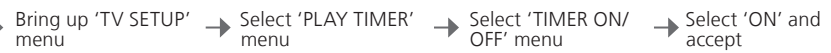

View, edit or delete a Timer

View, edit or delete a Timer from the list of settings you have entered.



Play Timer Enter up to six Play Timers. Make sure that the clock is set to the correct time for the Timers to be executed correctly, see p. 56. The TV cannot be part of an ordinary Play Timer or standby Timer until the Wake-up Timer has been carried out or disabled.

Safety For safety reasons, the stand will not turn if the TV is switched on by a Play Timer.

NOTE! Link room systems can perform the timed play or timed standby functions as well. However, you must programme Timers on your main room system and activate them on your link room system.

Edit and add TV channels

Rearrange the order in which the channels appear and provide them with a name of your own choice. You can also delete a channel or add new channels, if available. Preset up to 99 TV channels on channel numbers of their own.

Move a channel

You can move TV channels to the desired channel numbers.



Name a channel

Name the TV channels for easy recognition.



Delete a channel

Delete channels you do not want.



Adjust tuned channels

Fine tune channel reception, indicate the presence of coded channels and choose sound types, etc.



Re-tune via automatic tuning

Re-tune all TV channels automatically. Note that all channel settings you have made will disappear.



Add new channels

Add channels which, e.g., have been moved by the broadcaster. Tune in channels via the 'ADD CHANNELS' menu, to leave previously tuned channels unchanged and keep channel names, order, and settings stored for those channels.



Useful hints

- 'MANUAL TUNING'** The 'EXTRA' menu in the 'MANUAL TUNING' menu gives you access to the menu items 'FINE TUNE', '(DECODER)', '(TV SYSTEM)' and 'SOUND'.
- 'TV SYSTEM'** If the item 'TV SYSTEM' appears, make sure that the correct broadcast system is displayed before you begin tuning; 'B/G' (PAL/SECAM BG), 'I' (PAL I), 'L' (SECAM L), 'M' (NTSC M) and 'D/K' (PAL/SECAM D/K). For more information, contact your retailer.

NOTE! If channels are broadcasted with two languages and you want both languages, you can store the channel twice, once with each language.

Picture and sound settings are preset from the factory to neutral values which suit most viewing and listening situations. However, if you wish, you can adjust these settings to your liking.

Adjust picture

Adjust brightness, colour and contrast. For information on picture format, see p. 30. Adjustments made to the 'TINT' setting only apply to the current channel.

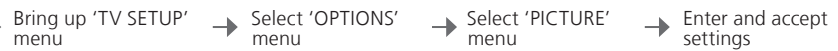

Mute the picture

Remove the picture from the screen temporarily.



Adjust sound

Preset volume, bass, treble or loudness, up to two connected BeoLab subwoofers and two default loudspeaker combinations. The contents of the 'SOUND' menu varies according to what you have connected to the TV. See also p. 30 about speaker combinations.

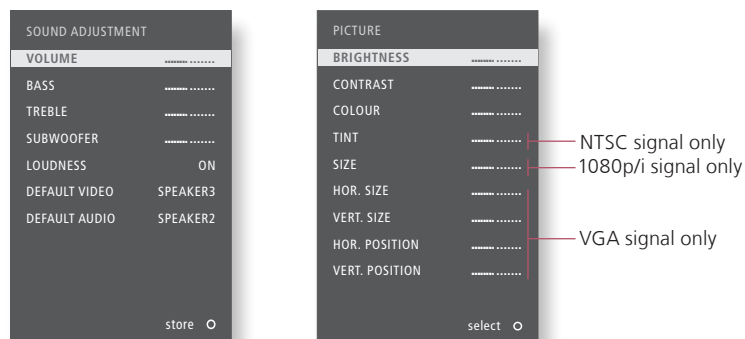
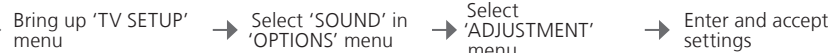

Temporary settings To only store picture and sound settings until you switch off the TV, press and hold **BACK** instead of the **centre** button when you accept the settings.

'DEFAULT VIDEO' The speaker combination chosen in the 'DEFAULT VIDEO' submenu is activated automatically when you switch on a video source in the TV.

'DEFAULT AUDIO' The speaker combination chosen in the 'DEFAULT AUDIO' submenu is activated automatically when you switch on an audio source in the TV.

NOTE! Do not allow still pictures, such as logos, video games, computer images, and images displayed in 4:3 format, to be displayed on the screen for an extended period of time. This can cause a permanent after-image to remain on the screen.

Calibrate colour accuracy of the screen

Automatic Colour Management ensures perfect colours on the screen continuously. During calibration, a sensor arm swings down from the TV frame and an on-screen bar changes between various greyscale colours.

Automatic calibration

Approximately for every 100 hours of use, the TV will initiate a calibration automatically, when you press the standby button.

→ We recommend that you let the TV perform calibration automatically, instead of manually.

Manual calibration

The TV must be switched on for more than two minutes and be in TV mode for the 'AUTO COLOUR MANAGEMENT' menu to be available.

Bring up 'TV SETUP' menu → Select 'OPTIONS' menu → Activate 'AUTO COLOUR MANAGEMENT' → Calibration process begins*

After manual calibration

→ Sensor arm retracts and TV returns to last chosen source

→ 'CALIBRATION COMPLETE' shortly appears on screen

Useful hints

¹***Manual calibration** All text is removed from the screen, the sensor arm swings down and the calibration starts.

Calibration failed If the sensor arm does not swing down fully, the calibration is not performed and the arm is retracted if needed. If the calibration was initiated automatically, the TV will attempt to execute the calibration the next time it is switched off.

NOTE! Never switch off your system or disconnect it from the mains during calibration.

The pincode system prevents people who do not know the pincode from using the TV. When the pincode system is activated and the TV has been disconnected from the mains for 15–30 minutes, the system goes into effect.

Activate the pincode system

Enter a four digit pincode to activate the system.

Bring up 'TV SETUP' menu

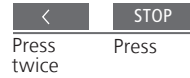

Enter a four digit code and accept

→ Re-enter the code and accept

Change the pincode

Change the pincode you have chosen.*¹

Bring up 'TV SETUP' menu

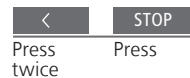

Enter pincode, accept and select 'NEW PINCODE'

→ Enter new code, accept, re-enter code and accept

Delete the pincode

Delete the pincode you have chosen.

Bring up 'TV SETUP' menu

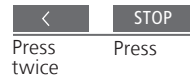

Enter pincode and accept

→ Select 'DELETE PINCODE' and accept

Enter the pincode

If you cannot switch on the TV after disconnection from the mains, wait 30 seconds and try again.

Enter pincode

→ Accept

If you forget the pincode

Contact your Bang & Olufsen retailer to receive a five digit mastercode.

Hold when prompted for pincode to display five fields*²

Enter five digit mastercode

→ Accept to delete pincode, you can now activate pincode system again

¹***Change of pincode** If you change your pincode more than five times within a three-hour period, the 'PINCODE' menu becomes inaccessible for three hours, assuming that the TV is not disconnected from the mains.
Incorrect pincode Five incorrect entries will cause the TV to shut down for three hours, during which operation is not possible. Disconnecting the TV resets the three-hour period.

NOTE! If you are prompted for a pincode the first time you switch on your TV, contact your Bang & Olufsen retailer. To cancel a pincode entry and clear the input fields, press **BACK**. On Beo4, press **STOP**.
²*On Beo4 hold **◀◀** to bring up the five fields.

Tuner setup

Disable the TV or DVB tuner, if your TV or DVB source is a peripheral unit, such as a set-top box.

Disable the internal tuner

If you disable the TV tuner, you can activate a connected peripheral unit with the **TV** button.
If you disable the DVB tuner, you can activate a connected peripheral unit with the **DTV** button.

Bring up 'TV SETUP' menu

→ Select 'TUNER SETUP' in 'OPTIONS' menu

→ Disable/enable 'TV TUNER'

→ Disable/enable 'DVB' and accept

Useful hints

Disable TV/DVB tuner If you disable both the TV tuner and the DVB tuner, you can activate a peripheral unit acting as tuner with either the **TV** button or the **DTV** button.

'TUNING' menu The 'TUNING' menu is only available if the TV tuner is enabled. See p. 58.

NOTE! If you have connected a Bang & Olufsen hard disc recorder to your TV, it is recommended not to disable the TV tuner.



Operate other equipment with Beo5 or Beo4

The built-in Peripheral Unit Controller acts as an interpreter between connected video equipment, such as a set-top box, recorder or DVD player, and your Bang & Olufsen remote control.



Beo5 operation

The main functions of your equipment can be operated with the Bang & Olufsen remote control. Not all functions may be supported.

→ Select source → Select function

Show menu overlay*¹

If you have a Beo4, the menu overlay gives you quick access to selected functions.

→ Select connected equipment →  or  → Bring up menu overlay → Select function

Direct Beo4 operation

Activate a function without the menu overlay. The connected equipment must be switched on.

→ Press coloured button to activate function →   → Select channel or  → Hold for Programme Guide

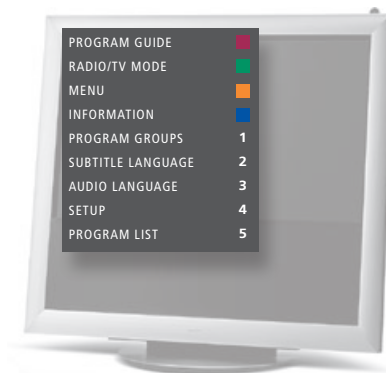

Useful hints

¹***Menu overlay** The menu overlay shows the options you have with a selected source. You can only bring up the menu overlay on the TV screen with a Beo4. With a Beo5 you have access to the corresponding functions via the Beo5 display. You cannot bring up the overlay in link rooms. Instead, press a desired coloured button or **GO** followed by a number.

NOTE! Which source button activates your peripheral unit depends on the tuner setup and settings in the 'CONNECTIONS' menu. See pp. 38 and 47.

Use the Bang & Olufsen remote control to gain access to the functions offered by your non-Bang & Olufsen equipment.

Use equipment menus

Operate a connected equipment's own menu via the remote control. On Beo4 you may have to press **EXIT** instead of **STOP** to return to a previous menu.

Bring up equipment menu



Navigate in menus

Select function

Step in pages/
channel lists^{2*}

Enter information

Playback on a DVD player

Switch on equipment, start and stop playback, and search back and forth.

Switch on DVD player



Backwards/
forwards

Once to pause
Twice to stop

Resume playback

^{2*}**Beo4** On Beo4 you have to press **GO** before the arrow buttons.
Switch on or off On some connected equipment you have to press **GO** then **0** to switch the equipment on and off if you have a Beo4.

NOTE! See also the guide enclosed with the connected equipment. For further information about supported equipment, contact your Bang & Olufsen retailer.



- 
- 44 Set up your television
 - 46 Expand your setup
 - 48 Set up additional equipment
 - 50 Connection panels
 - 52 First-time setup of your television
 - 54 Loudspeaker setup
 - 56 Additional settings
 - 58 On-screen menus
 - 58 Cleaning

Set up your television

Follow the guidelines for placement and connection described on this and the following pages.

Place the TV

When you place the TV, remember that the built-in motor unit will turn the TV to a preset position when you switch it on.

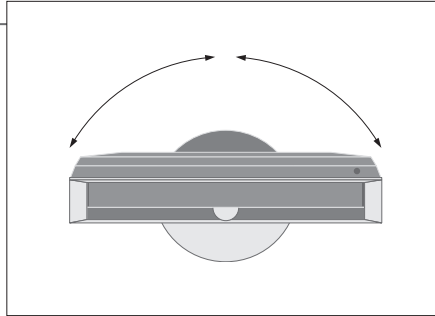

Due to the heavy weight of the TV, any moving or lifting of the TV should be performed by qualified personnel – using the proper equipment.

Remove supports

When you have placed the TV, remove the two supports beneath the front frame.

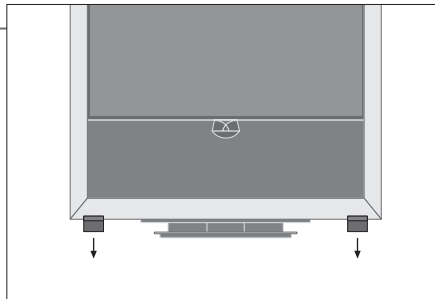

Unscrew the screws inside each support.

Fasten base cover

The cover has strips of double-coated tape on the back.

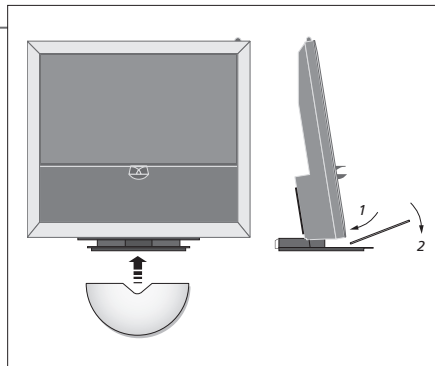

Before you fasten the cover permanently, try to put it into place without removing the tape backing.

Important

Ventilation To ensure proper ventilation, allow for at least 5 cm (2") of space on each side of the TV and 10 cm (4") above it. Do not cover the ventilation holes on the rear. At overheating (flashing standby indicator and an on-screen warning), switch off the TV to let it cool. You cannot operate the TV during this time.

Run cables

To allow for the movement when the TV turns, the cables must form a broad loop and be fastened to the cable bracket.

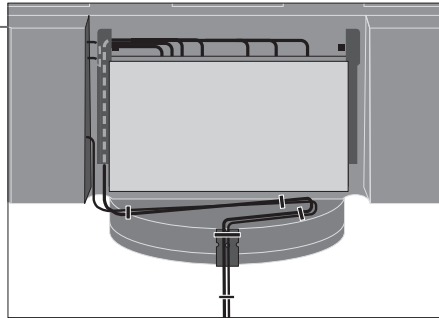

To decide how much 'slack' the cables need, gently turn the TV all the way to the left, before you fasten the cables with cable strips to make a 'neat' bundle of cables.

Overview

Locate the connection panels and other important items:

- 1 Standby indicator/receiver for remote control.
- 2 Side connection panel (input for mains supply, aerial input for TV signal, connections for BeoMaster).
- 3 Cable bracket.
- 4 Main connection panel with built-in tray and cover for cables.
Tilt the panel forward to remove cover.
Open tray along the side to ease access when running cables.

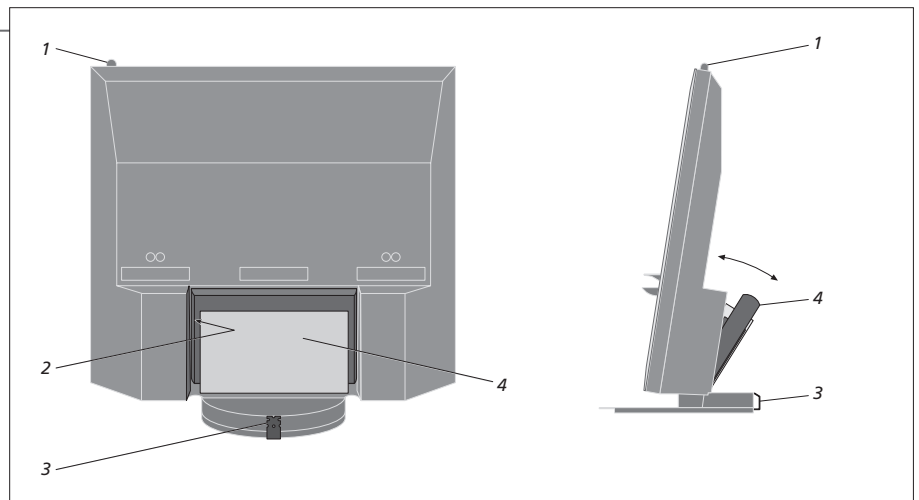

NOTE! Do not allow still pictures, such as logos, video games, computer images, and images displayed in 4:3 format, to be displayed on the screen for an extended period of time. This can cause a permanent after-image to remain on the screen.

Expand your setup

Your TV supports a wide range of additional equipment. You can even connect a projector or a home automation system to control room lights and curtains. Connect video recorders only to AV1 or AV2.

Disconnect from the mains

While expanding your setup, the TV must be disconnected from the mains.

→ Switch off TV

→ Disconnect TV from mains

Remove the cable cover

Remove the cable cover to get access to the connection panel.

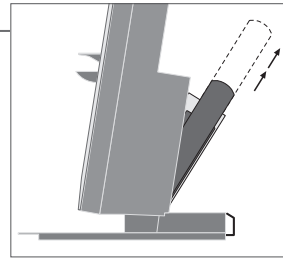

Tilt main connection panel forward

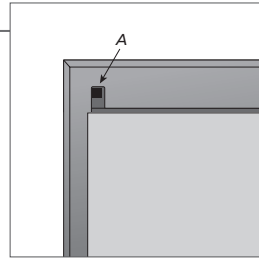

Release the two locks *A* and pull off cover

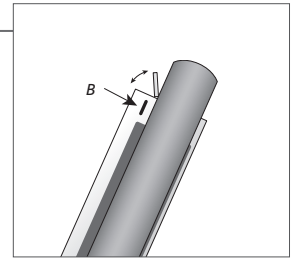

Press *B* to open the small door to sockets for temporary connections

Connect additional equipment

To operate non-Bang & Olufsen products with Beo5, attach a Bang & Olufsen IR-transmitter to each product. See also pp. 48-49.

→ Select corresponding socket marked CTRL

→ Make the connections

Switch on the TV

Always attach covers before you connect the TV to the mains.

→ Attach all covers

→ Connect TV to mains supply → Switch on TV

Information

- 'AUTO SELECTION'** Automatic selection of connected sources, when the TV is on and detects a signal.
- 'TIMER RECORDER'** Activate the Timer recording option for a connected recorder. Available if you do not have the optional Bang & Olufsen hard disc recorder. Only available in the 'AV1' and 'AV2' menus, and can only be activated in one of these menus at any time.
- 'HDMI'** Equipment connected via an HDMI IN socket. If you have set the 'HDMI EXPANDER' in the 'CONNECTIONS' menu to 'YES', the 'HDMI-C' option in the 'AV' menus is replaced with 'HDMI-C1', 'HDMI-C2', 'HDMI-C3', and 'HDMI-C4'.

Register additional equipment

Register the equipment you have connected to the TV, if it is not detected automatically by the TV. Repeat the procedure for each socket group.



Contents of the 'CONNECTIONS' menu	AV1–AV6	Register connected equipment
	DISPLAY 2	Register a connected projector
	HDMI EXPANDER	Enable or disable an HDMI Expander connected to the HDMI C socket
	LINK	Set a link frequency and enable the system modulator

Source options in the 'AV1–AV6' menu	NONE	Nothing connected
	V.MEM	Optional hard disc recorder or connected video recorder
	DVD/DVD2	Connected DVD player or recorder
	DTV2 (V.AUX)	Equipment, such as a set-top box
	DTV	Equipment, such as a set-top box
	V.AUX2	Equipment, such as a video game console
	TV	Connected TV tuner
	PC	BeoMaster or connected PC
	CENTRE	For connection of a source centre, which may contain up to six built-in sources (only in the 'AV2' menu)

The above are only examples of registrations, you can register available equipment to any source option. You may also have to register additional equipment in the Master Link system.

'(VGA)'	Equipment connected via VGA socket (AV5, available if you do not have the optional BeoMaster, or AV6).
'(Y – Pb – Pr)'	Equipment connected via Y – Pb – Pr socket (AV2 or AV3).
'STANDBY OPTIONS'	Set the set-top box to switch off when you switch source or when you switch off the TV. You can also choose that the set-top box should always be switched on or that it should be switched on and off manually by means of the remote control.

Set up additional equipment

Set up the TV with video sources and loudspeakers.

Video signals

Connect your video signals, such as a cable, antenna, or satellite to the sockets shown on the diagram to the right.

Loudspeakers

Use Bang & Olufsen Power Link speakers. Use the cables enclosed with the speakers. Longer cables are available from your Bang & Olufsen retailer.

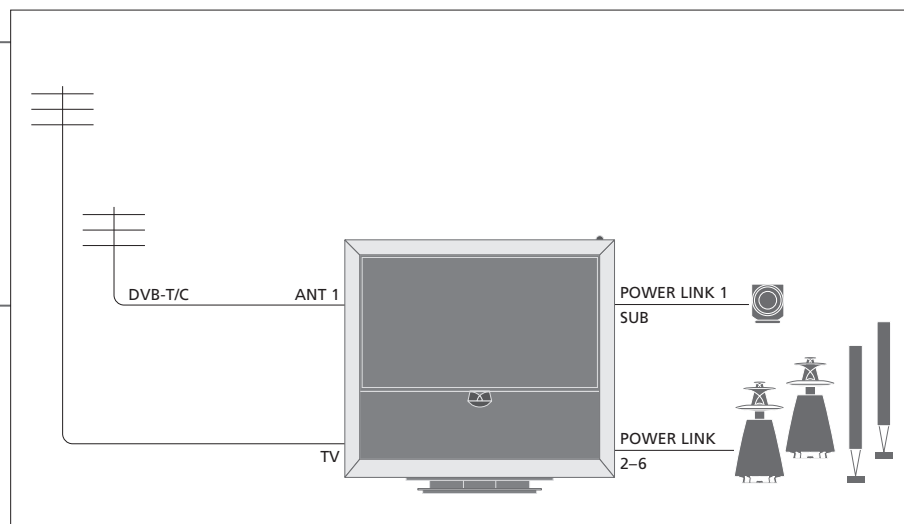

Additional video equipment

Connect many different types of video equipment at the same time. Here you can also see examples of source names you can select for the equipment in the 'CONNECTIONS' menu.

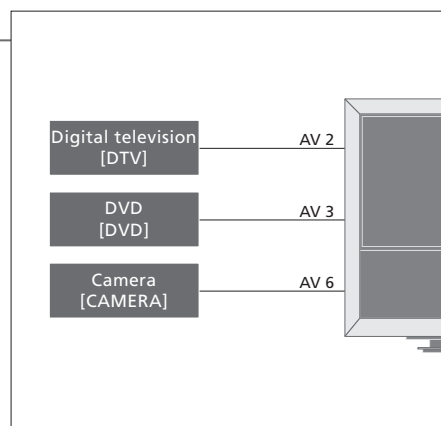

IR-transmitters: To operate non-Bang & Olufsen products with a Bang & Olufsen remote control, attach a Bang & Olufsen IR-transmitter to each of the products. Connect each transmitter to the corresponding socket marked CTRL on the main connection panel.

Useful hints

Equipment with HDMI output

Equipment with HDMI output can be connected to any available HDMI sockets, regardless of the particular AV socket group to which you have connected the equipment. For more information about how to set up connected equipment for use, see p. 47.

Expand your setup, for example in a home cinema system with a projector and a home automation system.

Home cinema setup

Use a projector or connect a home automation system to the TV, so you can control room lights and curtains.

IR-receiver

If the built-in IR-receiver for the remote control signals is hidden behind a lowered projector screen, you must set up an external IR-receiver as well.

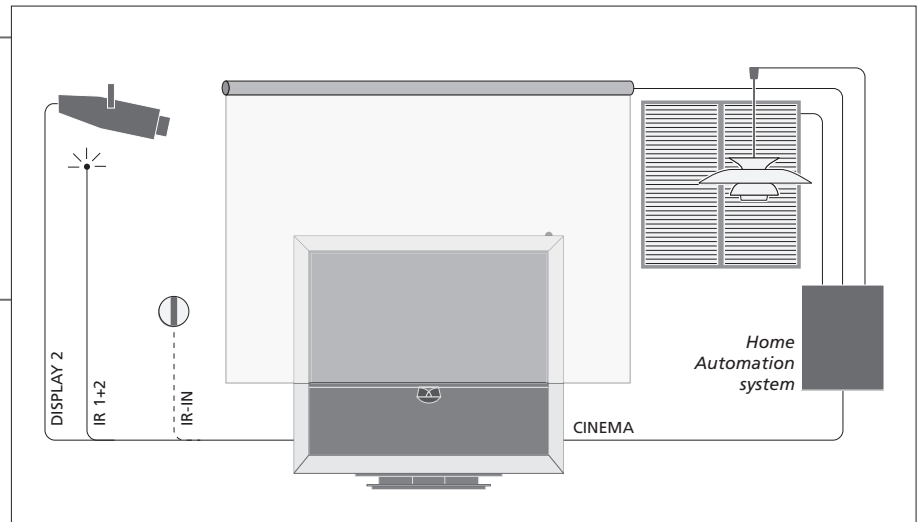

BeoMaster

If your TV is equipped with a BeoMaster, use the Ethernet socket on the side connection panel for connection to the Internet, and the two USB sockets to connect extra equipment to the BeoMaster, for example a memory card reader.

Audio system

Connect a Bang & Olufsen audio system with a Master Link socket to your TV. Connect it to the Master Link socket on the side connection panel. See also pp. 18–19.

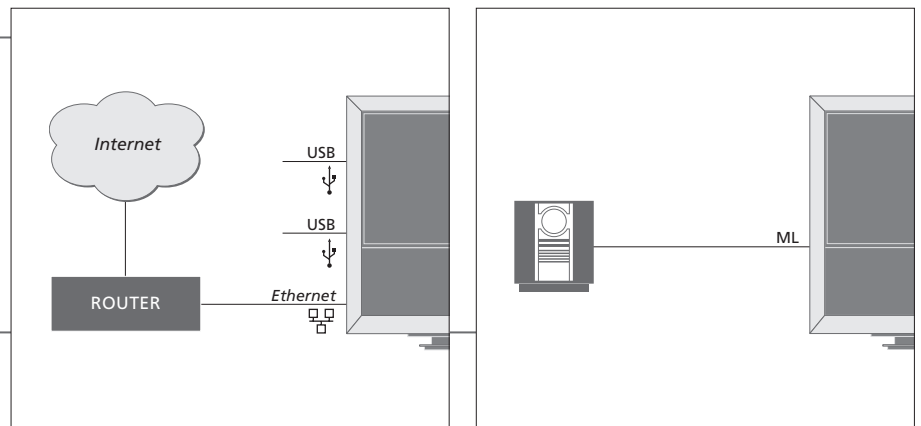

Mains cord and plug

The supplied mains cord and plug are specially designed for the TV. If you change the plug or in any way damage the mains cord, it can affect the TV performance. Connect the ~ socket on the side connection panel of your TV to the wall outlet. The IR-receiver lights up in red and the TV is in standby mode and ready to be used.

Connection panels

Any equipment you connect to the main connection panel must be registered in the 'CONNECTIONS' menu. See p. 47.

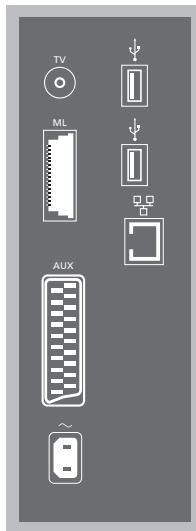
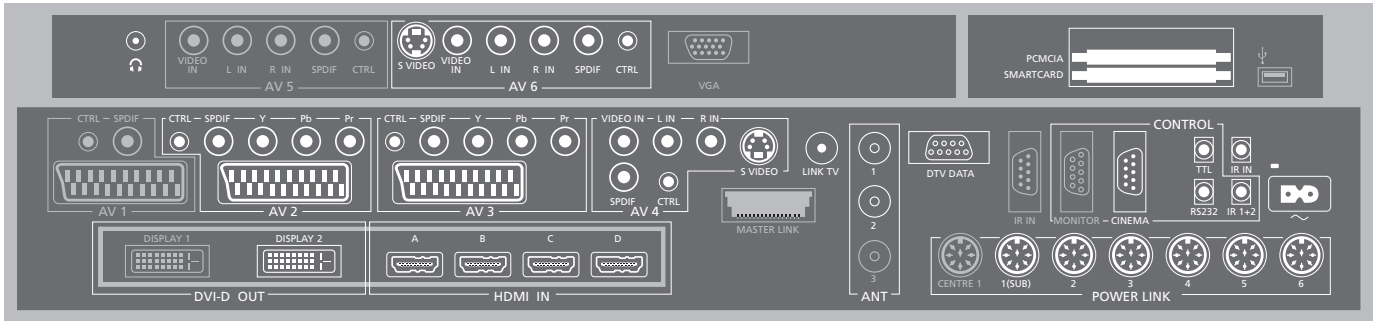

TV

Aerial input socket from external aerial/analogue cable TV network.

ML

For a compatible Bang & Olufsen audio system. Available only if the TV has a BeoMaster.

AUX

21-pin socket for additional video equipment to enable external copying.

→ USB

For connection of USB-enabled equipment. Available only if the TV has a BeoMaster.

🌐 Ethernet¹

For connection to the Internet. Available only if the TV has a BeoMaster.

~ ~ Mains supply

Connection to the mains supply.

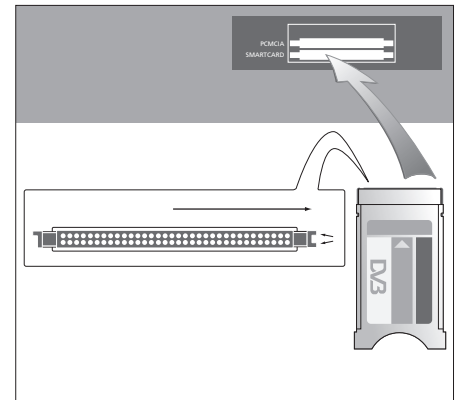

The CA module has one protruding edge on one side and two on the other side. The side with two edges should face right. When you insert a card, the gold chip should face upwards.

Useful hints

HDMI source You can watch two HDMI sources at the same time if one of the sources is connected to the HDMI A or HDMI B socket, and the other source is connected to the HDMI C or HDMI D socket.

¹*Only connect to a local area network (LAN) that does not exit your flat, house or building.

“Greyed out” sockets on the illustration of the main connection panel may be occupied by internal connections. Do not disconnect the cables from these sockets!



Connect stereo headphones.

AV1

Socket group occupied by the optional hard disc recorder.

AV2

Socket group for AV connection of additional video equipment.

AV3

Socket group for AV connection of additional video equipment.

The TV keeps a signal path open between the optional recorder and a recordable source connected to the AV3 socket area.

This allows you to set the source on AV3 to switch on automatically, as well as set the optional recorder for timed recording of the source on AV3, provided your connected equipment supports these functions.

AV4

Socket group for AV connection of additional video equipment.

AV5

This socket group is only available if your TV is not equipped with a BeoMaster. Use this socket group for equipment which you do not wish to have permanently connected, e.g. a camera or a camcorder.

AV6

Use this socket group for equipment which you do not wish to have permanently connected, e.g. a camera or a camcorder.

VIDEO IN (AV4)

For video signal.

L-IN, R-IN (AV4–AV6)

Right and left line input.

Y – Pb – Pr (AV2–AV3)

For video signals from an external source, e.g. HDTV source. You can use the socket in conjunction with an AV socket or a digital audio socket.

SPDIF (AV2–AV6)

Digital audio input socket, e.g. DVD player.

CTRL (AV2–AV6)

For IR control signals to external equipment connected to an AV socket.

S VIDEO (AV4, AV6)

For S-VHS or Hi-8 Camcorders.

DISPLAY 2 (DVI-D OUT)

Connect a projector.

HDMI IN (A–D)

For High Definition Multimedia Interface video source or PC. The sources can be registered to any of the AV socket groups. Connect an HDMI Expander to the HDMI C socket.

VGA

Socket for connection of a High Definition video source or a PC.

ANT (1–3)

Aerial input socket (1 – DVB–T/C) from external aerial/cable TV network (2 – DVB–S) from satellite dish, external aerial/cable TV network (3) occupied by optional hard disc recorder.

MASTER LINK

For a compatible Bang & Olufsen audio system. Available if the TV does not have a BeoMaster.

LINK TV

Aerial output for distribution of video signals to other rooms.

DTV DATA

For future use.

CINEMA

For a Home Automation System.

TTL/RS232

Only for use in Hotel setups.

IR IN

For an extra IR-receiver when the TV is set up with a projector.

IR 1+2

For an external IR-transmitter used with Home cinema setups.

PCMCIA/SMARTCARD

For a card/module for access to digital satellite channels.

→ USB (on the main socket panel)

For service use only.

Headphones To mute speakers turn the volume wheel quickly counter-clockwise. Turn the volume wheel either way to adjust volume in headphones. To restore sound in speakers, turn the volume wheel quickly counter-clockwise.

POWER LINK 1 (SUB) Use a cable splitter to connect two Bang & Olufsen subwoofers.

POWER LINK 2–6 For external speakers in a surround sound setup. See also pp. 54–55.

NOTE! Video recorders can only be connected to the AV1 and AV2 socket groups, as these are the only sockets groups for video output. Connect the primary recorder to AV1 and the secondary recorder to AV2.

First-time setup of your television

This first-time setup procedure is activated when the TV is connected to the mains and switched on for the first time. If you want to change your setup at a later date, you can access the same menus and update your settings.

Switch on the TV



It takes the TV approx. 20 seconds to start up and become ready for use.

Switch on

Make settings

You are led through the following settings only when you switch on the TV for the first time.*¹



Select setting



Accept and go to next menu item

MENU LANGUAGE

Set the on-screen menu language

TUNER SETUP

Disable or enable internal TV tuner or DVB

CONNECTIONS

Register connected equipment, see p. 47

AUTO TUNING

Tune in TV channels automatically, see also p. 34. Available only if the TV tuner is enabled, see p. 38

Information

Menu language	Select the language for on-screen menus.
TV tuner	The 'TUNING' menu is only available if the TV tuner is enabled, see pp. 38 and 58.
Connections	Select the type of equipment connected to each socket, the sockets used, the product name, and the source name.
Auto tuning	A menu for channel tuning automatically appears on the screen.

¹*NOTE! When you have made the preferred settings in a menu, you may have to press the green button to continue to the next menu in the first-time setup procedure. Follow on-screen instructions.

When first-time setup is complete, you can then set up your loudspeakers for Home cinema use.

Calibrate the speakers

Set up the speakers to optimise sound from your listening position.

SPEAKER TYPES

First-time setup of loudspeakers applies only to speakers for TV viewing. After first-time setup, you can set up speakers for Home cinema viewing. See also *'Loudspeaker setup'* on pp. 54–55 and *'Surround sound and Home cinema'* on p. 30.

SPEAKER ROLES

SPEAKER DISTANCE

SPEAKER LEVEL

SOUND ADJUSTMENT

Adjust volume, bass, treble and loudness and preset two default speaker combinations. Select a different speaker combination at any time. See p. 35.

Calibrate the stand

The motorised movement of the TV will not work until the calibration process has been completed.

STAND ADJUSTMENT

<	>	GO
At 'SET LEFTMOST POSITION' turn left to the point you wish to restrict the movement to	At 'SET RIGHTMOST POSITION' turn right to the point you wish to restrict the movement to	Accept

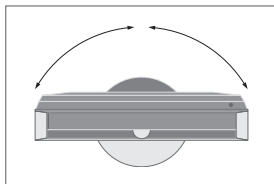

STAND POSITIONS

Set preferred preset position for the TV to turn to, when it is switched on and off. See p. 56.

Stand adjustment Set the maximum angle the TV will turn – left and right.

NOTE! You need to calibrate the stand before you can use the motorised movement of the stand.

Loudspeaker setup

Add Power Link speakers and up to two BeoLab subwoofers to your TV and you have a surround sound system.

Select speaker setup

Switch on the TV in TV or Home cinema mode before you adjust speaker settings for either mode.

Switch on TV and bring up 'TV SETUP' menu → Select 'SOUND' in 'OPTIONS' menu → Select menu

Set speaker type

Register the type of each speaker in the menu. Each Bang & Olufsen speaker makes a sound and is highlighted on the screen.

Select 'SPEAKER TYPES' menu → Select speaker and reveal speaker type → **GO** → Accept

Set speaker role

Select the function for each connected loudspeaker, such as front, back or surround. A speaker can have more than one role – one for TV viewing and one for Home cinema viewing.

Select 'SPEAKER ROLES' menu → Reveal speaker role for each speaker → **GO** → Accept

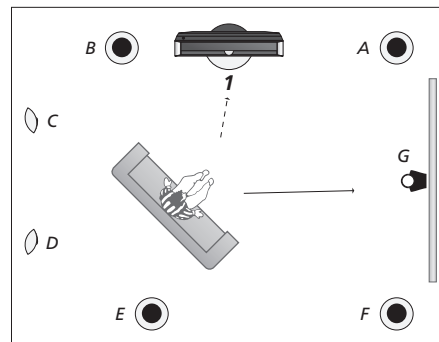

Set speaker role.

<i>TV (1)</i>	<i>Home cinema (2)</i>
A: Right front	Left front
B: Left front	Left surround
C: Off	Left back
D: Off	Right back
E: Left back	Right surround
F: Right back	Right front
G: Off	Centre

Information

Sound during setup During the setup process, a sound is sometimes produced by a speaker. Check if the highlighted speaker matches the name of the speaker making the sound.

Speaker roles You must select the surround speakers before you can select the back speakers.

NOTE! To make a Home cinema setup, you must first switch to Home cinema mode. For information about Home cinema, see p. 30.

If your setup includes two different viewing positions, a Home cinema setup and a regular TV viewing setup, you must make two different loudspeaker settings.

Set speaker distance

Enter the straight-line distances in metres between your favourite viewing position and the individual speakers.

Select 'SPEAKER DISTANCE' menu

→ Select speaker and select distance

→ **GO**
Accept

Calibrate the sound level

A calibration sound is produced alternately in each speaker. Adjust the speakers to match the centre speaker's sound level.

Select 'SPEAKER LEVEL' menu

→ Select 'AUTOMATIC' or 'MANUAL' in 'SEQUENCE'

→ If 'MANUAL' is selected, select speaker and adjust level

→ **GO**
Accept

See active sound system

See the name of the active sound system for a source or programme on the screen.

Bring up 'TV SETUP' menu

→ Select 'SOUND' in 'OPTIONS' menu

→ Select 'SOUND SYSTEM' menu

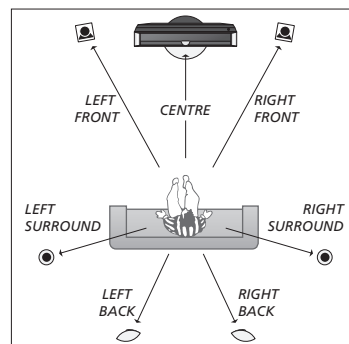

Set speaker distance.

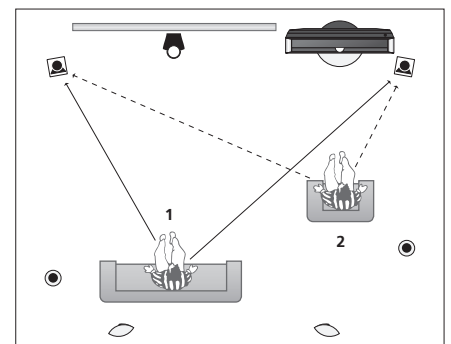

Calibrate sound level from two different viewing positions.

Speaker level Calibrate each speaker in reference to the centre speaker to ensure an optimal surround sound.

NOTE! Once you have performed the speaker calibration, you will only need to re-calibrate the speaker sound if you make changes to the setup.

Additional settings

You have the possibility to make additional settings, such as to set the positions for the TV to turn to, to set the correct time and date and to activate, adjust and deactivate functions related to day-to-day use of the optional hard disc recorder.

Positions of the TV

Programme a position for when you watch TV, listen to music, and when the TV is switched off. See p. 53 about first-time installation of the stand.

Bring up 'TV SETUP' menu and select 'STAND POSITIONS' menu

Select 'VIDEO', 'AUDIO' or 'STANDBY'

→ Turn TV as desired

→  Accept*¹

Time and date

Set the time and date. Press **Clock** on Beo5 to bring up the clock on the display. It disappears again after 10 seconds.

Bring up 'TV SETUP' menu and select 'OPTIONS' menu

Select 'CLOCK' menu

→ Set time and date

→  Accept

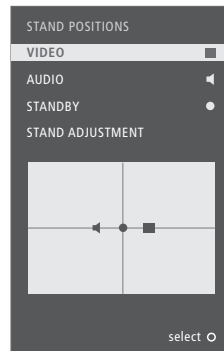

Information

¹***First-time setup** During first-time setup, when you have set the TV positions, press the green button to continue first-time setup.

NOTE! The simplest way to set the clock is to synchronise it with the teletext service offered by the current TV channel via the 'CLOCK' menu. If a teletext service is not available, you can set the clock manually.

Set up hard disc recorder

The two settings for feature level – 'BASIC' and 'ADVANCED' – determine the content of the 'SETUP' menu.

Switch on hard disc recorder and bring up main menu

→ Select 'SETUP' menu → Select option and change settings



→ Accept

FEATURE LEVEL	Select 'BASIC' or 'ADVANCED' level
PARENTAL LOCK CODE* ²	Enter an access code for limited access to recordings
GROUPS* ²	Eight predefined groups to place recordings in
RECORDING QUALITY* ²	Quality of recordings ('STANDARD'/'HIGH')
RECORDING DURATION	Standard length for manual recordings
CONNECTIONS	Register additional connected equipment
REPLAY* ²	'EXTENDED' replay starts copying to the buffer as soon as you choose a source. See also pp. 8–9
MENU LANGUAGE	Choose between eight languages for the menu system
TUNING* ³	Fine tune the programmes stored on the hard disc recorder's own tuner and adjust the sound setting
CLOCK* ³	Follows the time and date settings for the TV automatically

²*Hard disc recorder Functions marked with *² are only available if you set 'FEATURE LEVEL' to 'ADVANCED'.
³*Tuning and clock In the 'ADVANCED' level 'TUNING' and 'CLOCK' is found under 'EXTRA'.
 Recording quality 'STANDARD' quality occupies less space on the hard disc than 'HIGH'.

General settings: Select your Zone, TV and Menu.

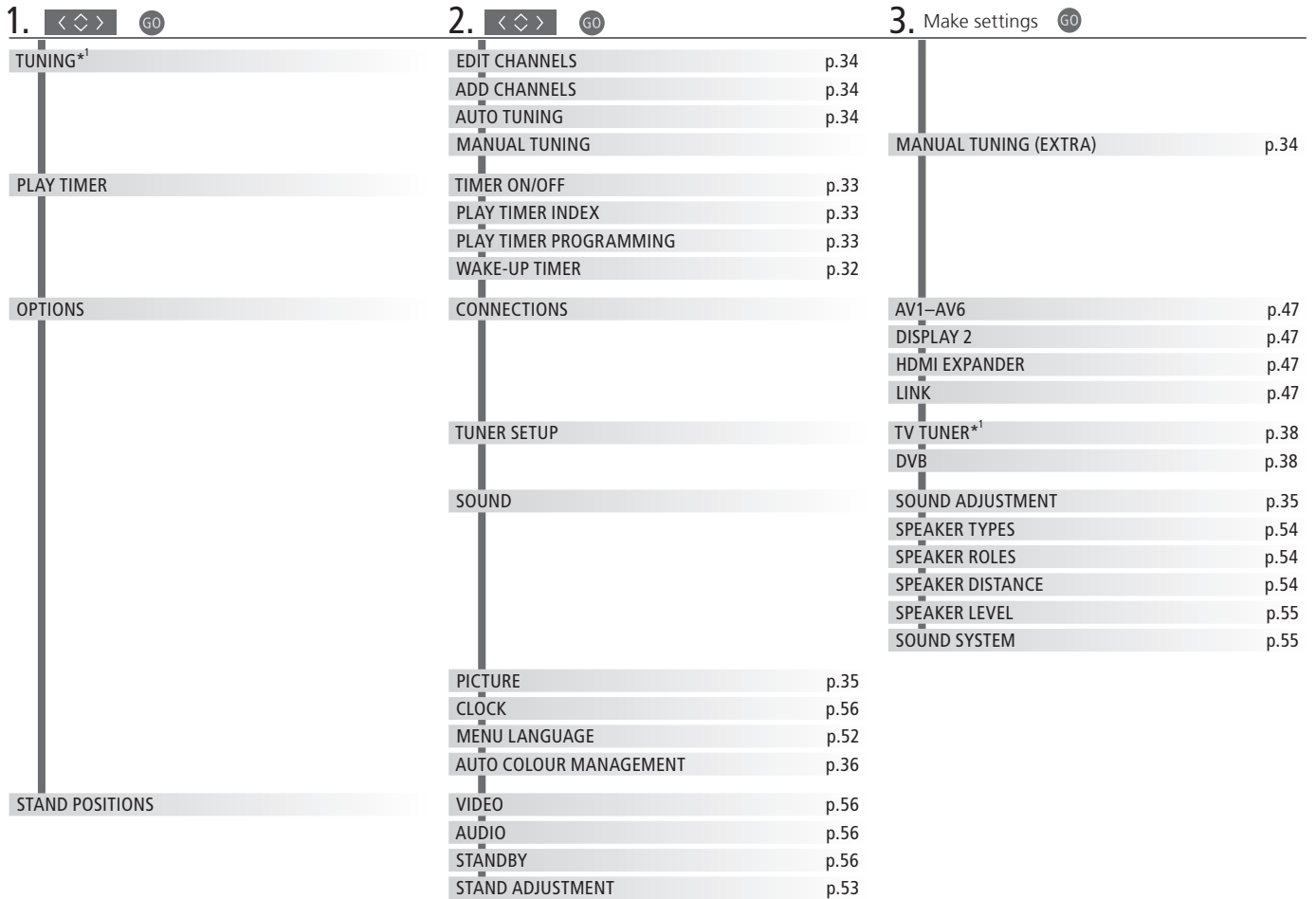

Cleaning

Maintenance	Regular maintenance, such as cleaning, is the responsibility of the user.
Screen	Use a soft, dry cloth to wipe dust off the screen. Do not use liquid cleaners or aerosol cleaners.
Cabinet and controls	Wipe dust off the surfaces using a dry, soft cloth. To remove stains or dirt, use a soft, damp cloth and a solution of water and mild detergent, such as washing-up liquid.
Never alcohol	Never use alcohol or other solvents to clean any parts of the TV.

Optional hard disc recorder: Select your Zone, V.MEM and Menu.

1. <◇> GO

HARD DISC CONTENTS	
TIMER PROGRAMMING	
TIMER INDEX	p.26
SETUP	
RECORD/STOP RECORDING	pp.4-5

2. <◇> GO

EDIT* ²	
OPTIONS* ²	
GROUP* ²	p.28
SOURCE	p.26
CHANNEL	p.26
START TIME	p.26
STOP TIME	p.26
DATE/WEEKDAYS	p.26
PROTECTION* ²	p.26
QUALITY* ²	p.26
EXTRA* ²	
FEATURE LEVEL	
PARENTAL LOCK CODES* ²	
GROUPS* ²	
RECORDING QUALITY* ²	
RECORDING DURATION	
CONNECTIONS	
REPLAY* ²	
MENU LANGUAGE	p.57
EXTRA* ²	

3. Make settings GO

DELETE	p.27
SPLIT	p.27
TRIM	p.27
EXTERNAL COPY	p.28
PROTECTION	p.27
GROUP	p.28
NAME	p.27
PARENTAL LOCK	p.29
GROUP	p.26
NAME	p.26
PARENTAL LOCK	p.26
KEEP EPISODES	p.26
BASIC – ADVANCED	p.57
OLD CODE – NEW CODE ...	p.57
MOVIES – SPORTS ...	p.57
STANDARD – HIGH	p.57
MANUAL RECORDING	p.57
NONE – V.MEM – DVD ...	p.57
OFF – BASIC – EXTENDED	p.57
TUNING	p.57
CLOCK	p.57

FEATURE LEVEL Default setting from the factory is 'BASIC'.

¹*NOTE! The 'TUNING' menu is only available if the TV tuner is enabled in the 'TUNER SETUP' menu.

²*'ADVANCED' feature level only.

Safety copy and anti-virus program

Always keep copies of your data to ensure that your photos, music files, etc. are not lost in the event of a system or program failure. The BeoMaster features an anti-virus program that blocks the most common computer viruses.

Safety copy

It is the responsibility of the user to regularly make safety copies of the data, including but not limited to files, photos, music, etc. It is the responsibility of the user to ensure that this data is available on media which can be immediately transferred back to the BeoMaster or in the event that the BeoMaster is replaced, to the new BeoMaster, and it is the responsibility of the user to reinstall these safety copies when necessary.

A safety copy may be placed on your office computer or any other external devices, such as a portable hard disk, or the data may be copied to CD-roms or DVD discs.

Data must also be safety copied when handing in the BeoMaster for service. Often it will be necessary to format data media as part of the repair and such formatting with the consequential loss of data will take place without notice. Bang & Olufsen cannot be held liable for any loss of data.

Re-installation of data

In case you need to re-install your media collection on the BeoMaster, you must use BeoPlayer, BeoPort or BeoConnect (for MAC users only) software to transfer your collection to the BeoMaster. This ensures that you will not lose the associated tag information.

Anti-virus program

A virus attack can result in system breakdown and loss of important data. In serious cases the BeoMaster may have to be handed in for service. A repair caused by a virus attack is NOT covered by guarantee. The BeoMaster features an anti-virus program. The program protects against the most commonly used hacker programs. The program is automatically updated for a least five years via the Internet provided that the BeoMaster is constantly connected to the Internet. The program is installed to instantly and without notification remove all files containing a virus. Files transferred to the BeoMaster may be deleted as a result.

Bang & Olufsen cannot be held liable for an loss as a consequence of virus attack.

On the BeoMaster a limited edition of Windows XP® is embedded. To use this edition, you must read the EULA terms below.

EULA Terms

You have acquired a device, a BeoMaster, that includes software licensed by AmiTech from Microsoft Licensing, GP or its affiliates. Those installed software products of MS origin, as well as associated media, printed materials, and online or electronic documentation, are protected by international intellectual property laws and treaties. The SOFTWARE is licensed, not sold. All rights reserved.

IF YOU DO NOT AGREE TO THIS END USER LICENSE AGREEMENT EULA, DO NOT USE THE DEVICE OR COPY THE SOFTWARE. INSTEAD, PROMPTLY CONTACT AMITECH FOR INSTRUCTIONS ON RETURN OF THE UNUSED DEVICE; FOR A REFUND. ANY USE OF THE SOFTWARE, INCLUDING BUT NOT LIMITED TO USE ON THE DEVICE, WILL CONSTITUTE YOUR AGREEMENT TO THIS EULA (OR RATIFICATION OF ANY PREVIOUS CONSENT).

GRANT OF SOFTWARE LICENSE. This EULA grants you the following license: You may use the SOFTWARE only on the DEVICE.

NOT FAULT TOLERANT. THE SOFTWARE IS NOT FAULT TOLERANT. AMITECH HAS INDEPENDENTLY DETERMINED HOW TO USE THE SOFTWARE IN THE DEVICE, AND MS HAS RELIED UPON AMITECH TO CONDUCT SUFFICIENT TESTING TO DETERMINE THAT THE SOFTWARE IS SUITABLE FOR SUCH USE.

NO WARRANTIES FOR THE SOFTWARE. THE SOFTWARE is provided AS IS and with all faults. THE ENTIRE RISK AS TO SATISFACTORY QUALITY, PERFORMANCE, ACCURACY, AND EFFORT (INCLUDING LACK OF NEGLIGENCE) IS WITH YOU. ALSO, THERE IS NO WARRANTY AGAINST INTERFERENCE WITH YOUR ENJOYMENT OF THE SOFTWARE OR AGAINST INFRINGEMENT. IF YOU HAVE RECEIVED ANY WARRANTIES REGARDING THE DEVICE OR THE SOFTWARE, THOSE WARRANTIES DO NOT ORIGINATE FROM, AND ARE NOT BINDING ON, MS. No Liability for Certain Damages. EXCEPT AS PROHIBITED BY LAW, MS SHALL HAVE NO LIABILITY FOR ANY INDIRECT, SPECIAL, CONSEQUENTIAL OR INCIDENTAL DAMAGES ARISING FROM OR IN CONNECTION WITH THE USE OR PERFORMANCE OF THE SOFTWARE. THIS LIMITATION SHALL APPLY EVEN IF ANY REMEDY FAILS OF ITS ESSENTIAL PURPOSE. IN NO EVENT SHALL MS BE LIABLE FOR ANY AMOUNT IN EXCESS OF U.S. TWO HUNDRED FIFTY DOLLARS (U.S. \$250.00)

Limitations on Reverse Engineering, Decompilation, and Disassembly. You may not reverse engineer, decompile, or disassemble the SOFTWARE, except and only to the extent that such activity is expressly permitted by applicable law notwithstanding this limitation.

SOFTWARE TRANSFER ALLOWED BUT WITH RESTRICTIONS. You may permanently transfer rights under this EULA only as part of a permanent sale or transfer of the Device, and only if the recipient agrees to this EULA. If the SOFTWARE is an upgrade, any transfer must also include all prior versions of the SOFTWARE.

EXPORT RESTRICTIONS. You acknowledge that SOFTWARE is subject to U.S. export jurisdiction. You agree to comply with all applicable international and national laws that apply to the SOFTWARE, including the U.S. Export Administration Regulations, as well as end-user, end-use and destination restrictions issued by U.S. and other governments. For additional information see <http://www.microsoft.com/exporting/>

Waste Electrical and Electronic Equipment (WEEE) – Environmental protection



Electrical and electronic equipment, parts and batteries marked with this symbol must not be disposed of with normal household wastage; all electrical and electronic equipment, parts and batteries must be collected and disposed of separately.

When disposing of electrical and electronic equipment and batteries by use of the collection systems available in your country, you protect the environment, human health and contribute to the prudent and rational use of natural resources. Collecting electrical and electronic equipment, batteries and waste prevents the potential

contamination of nature with the hazardous substances which may be present in electrical and electronic products and equipment. Your Bang & Olufsen retailer will advise you of the correct way of disposal in your country.

If a product is too small to be marked with the symbol, it will appear in the User Guide, on the Guarantee certificate, or on the packaging.

CE *This product is in conformity with the provisions of the Directives 2004/108/EC and 2006/95/EC.*

This product incorporates copyright protection technology that is protected by U.S. patents and other intellectual property rights. Use of this copyright protection technology must be authorized by Macrovision, and is intended for home and other limited viewing uses only unless otherwise authorized by Macrovision. Reverse engineering or disassembly is prohibited.

This product incorporates copyright protection technology that is protected by U.S. patents and other intellectual property rights. Use of this copyright protection technology must be authorized by Macrovision, and is intended for home and other limited viewing uses only unless otherwise authorized by Macrovision. Reverse engineering or disassembly is prohibited.



Acknowledgements and liability

Product names mentioned in this guide may be trademarks or registered trademarks of other companies.

Portions utilize Microsoft Windows Media Technologies. Copyright © 1999–2002 Microsoft Corporation. All rights reserved. Microsoft, Windows Media and the Windows Logo are registered trademarks of Microsoft Corporation in the United States and/or other countries.

Please note that Bang & Olufsen will, in no event, be liable for any consequential, incidental or indirect damages arising out of the use or inability to use the software.

Manufactured under license from Dolby Laboratories. Dolby, Pro Logic, and the double-D symbol are registered trademarks of Dolby Laboratories.

Confidential unpublished works.
Copyright 1992–2003 Dolby Laboratories.
All rights reserved.

Manufactured under license under U.S. Patent #'s: 5,451,942; 5,956,674; 5,974,380; 5,978,762; 6,487,535; 7,003,467; 7,212,872 & other U.S. and worldwide patents issued & pending.

DTS, DTS Digital Surround, ES, and Neo:6 are registered trademarks and the DTS logos, and Symbol are trademarks of DTS, Inc.

© 1996–2008 DTS, Inc.
All Rights Reserved.

